

Mystere MX170E (2014)

Type III - Chevrolet Express 4500

DRAWING NO.	REV	DESCRIPTION	VIEW	CLIENT
31GM-G4500XX-C4-0310	0	CHEVROLET G4500 TYPE III AMBULANCE	GENERAL EXTERIOR	MYSTERE MX170E
31GM-G4500XX-C4-0311	0	CHEVROLET G4500 TYPE III AMBULANCE	EXTERIOR DIMENSIONS	MYSTERE MX170E
31GM-G4500XX-C4-0312	0	CHEVROLET G4500 TYPE III AMBULANCE	CURBSIDE EXTERIOR - STANDARD	MYSTERE MX170E
31GM-G4500XX-C4-0313	0	CHEVROLET G4500 TYPE III AMBULANCE	CURBSIDE EXTERIOR - OPTION	MYSTERE MX170E
31GM-G4500XX-C4-0314	0	CHEVROLET G4500 TYPE III AMBULANCE	STREETSIDE EXTERIOR - STANDARD	MYSTERE MX170E
31GM-G4500XX-C4-0315	0	CHEVROLET G4500 TYPE III AMBULANCE	STREETSIDE EXTERIOR - OPTION	MYSTERE MX170E
31GM-G4500XX-C4-0316	0	CHEVROLET G4500 TYPE III AMBULANCE	FRONT EXTERIOR - STANDARD	MYSTERE MX170E
31GM-G4500XX-C4-0317	0	CHEVROLET G4500 TYPE III AMBULANCE	FRONT EXTERIOR - OPTION	MYSTERE MX170E
31GM-G4500XX-C4-0318	0	CHEVROLET G4500 TYPE III AMBULANCE	REAR EXTERIOR - STANDARD	MYSTERE MX170E
31GM-G4500XX-C4-0319	0	CHEVROLET G4500 TYPE III AMBULANCE	REAR EXTERIOR - OPTION	MYSTERE MX170E
31GM-G4500XX-C4-0320	0	CHEVROLET G4500 TYPE III AMBULANCE	CURBSIDE WALL - SQUAD BENCH - STANDARD	MYSTERE MX170E
31GM-G4500XX-C4-0321	0	CHEVROLET G4500 TYPE III AMBULANCE	CURBSIDE WALL - SQUAD BENCH - OPTION	MYSTERE MX170E
31GM-G4500XX-C4-0322	0	CHEVROLET G4500 TYPE III AMBULANCE	CURBSIDE WALL - MOBILITY SEAT	MYSTERE MX170E
31GM-G4500XX-C4-0323	0	CHEVROLET G4500 TYPE III AMBULANCE	CURBSIDE WALL - MOBILITY SEAT - OPTION	MYSTERE MX170E
31GM-G4500XX-C4-0324	0	CHEVROLET G4500 TYPE III AMBULANCE	CURBSIDE WALL - DUAL CAPTAIN SEAT	MYSTERE MX170E
31GM-G4500XX-C4-0325	0	CHEVROLET G4500 TYPE III AMBULANCE	CURBSIDE WALL - DUAL CAPTAIN SEAT - OPTION	MYSTERE MX170E
31GM-G4500XX-C4-0326	0	CHEVROLET G4500 TYPE III AMBULANCE	STREETSIDE WALL - CPR SEAT - STANDARD	MYSTERE MX170E
31GM-G4500XX-C4-0327	0	CHEVROLET G4500 TYPE III AMBULANCE	STREETSIDE WALL - CPR SEAT - OPTION	MYSTERE MX170E
31GM-G4500XX-C4-0328	0	CHEVROLET G4500 TYPE III AMBULANCE	STREETSIDE WALL - CAPTAIN CPR SEAT	MYSTERE MX170E
31GM-G4500XX-C4-0329	0	CHEVROLET G4500 TYPE III AMBULANCE	STREETSIDE WALL - CAPTAIN CPR SEAT - OPTION	MYSTERE MX170E
31GM-G4500XX-C4-0330	0	CHEVROLET G4500 TYPE III AMBULANCE	STREETSIDE WALL - FULL CABINET	MYSTERE MX170E
31GM-G4500XX-C4-0331	0	CHEVROLET G4500 TYPE III AMBULANCE	STREETSIDE WALL - FULL CABINET - OPTION	MYSTERE MX170E
31GM-G4500XX-C4-0332	0	CHEVROLET G4500 TYPE III AMBULANCE	FRONT WALL - STANDARD	MYSTERE MX170E
31GM-G4500XX-C4-0333	0	CHEVROLET G4500 TYPE III AMBULANCE	FRONT WALL - OPTION	MYSTERE MX170E
31GM-G4500XX-C4-0334	0	CHEVROLET G4500 TYPE III AMBULANCE	REAR WALL - STANDARD	MYSTERE MX170E
31GM-G4500XX-C4-0335	0	CHEVROLET G4500 TYPE III AMBULANCE	REAR WALL - OPTION	MYSTERE MX170E
31GM-G4500XX-C4-0336	0	CHEVROLET G4500 TYPE III AMBULANCE	FLOOR VIEW - STANDARD	MYSTERE MX170E
31GM-G4500XX-C4-0337	0	CHEVROLET G4500 TYPE III AMBULANCE	FLOOR VIEW - OPTION #1	MYSTERE MX170E
31GM-G4500XX-C4-0338	0	CHEVROLET G4500 TYPE III AMBULANCE	FLOOR VIEW - OPTION #2	MYSTERE MX170E
31GM-G4500XX-C4-0339	0	CHEVROLET G4500 TYPE III AMBULANCE	FLOOR VIEW - OPTION #3	MYSTERE MX170E
31GM-G4500XX-C4-0340	0	CHEVROLET G4500 TYPE III AMBULANCE	CEILING VIEW - STANDARD	MYSTERE MX170E
31GM-G4500XX-C4-0341	0	CHEVROLET G4500 TYPE III AMBULANCE	CEILING VIEW - OPTION	MYSTERE MX170E
31GM-G4500XX-C4-0342	0	CHEVROLET G4500 TYPE III AMBULANCE	FRONT CONSOLE - STANDARD	MYSTERE MX170E
31GM-G4500XX-C4-0343	0	CHEVROLET G4500 TYPE III AMBULANCE	FRONT CONSOLE - OPTION	MYSTERE MX170E
31GM-G4500XX-C4-0344	0	CHEVROLET G4500 TYPE III AMBULANCE	REAR CONSOLES - STANDARD	MYSTERE MX170E
31GM-G4500XX-C4-0345	0	CHEVROLET G4500 TYPE III AMBULANCE	REAR CONSOLES - OPTION	MYSTERE MX170E

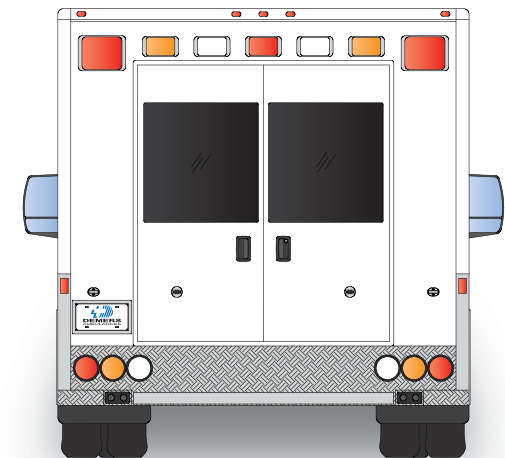
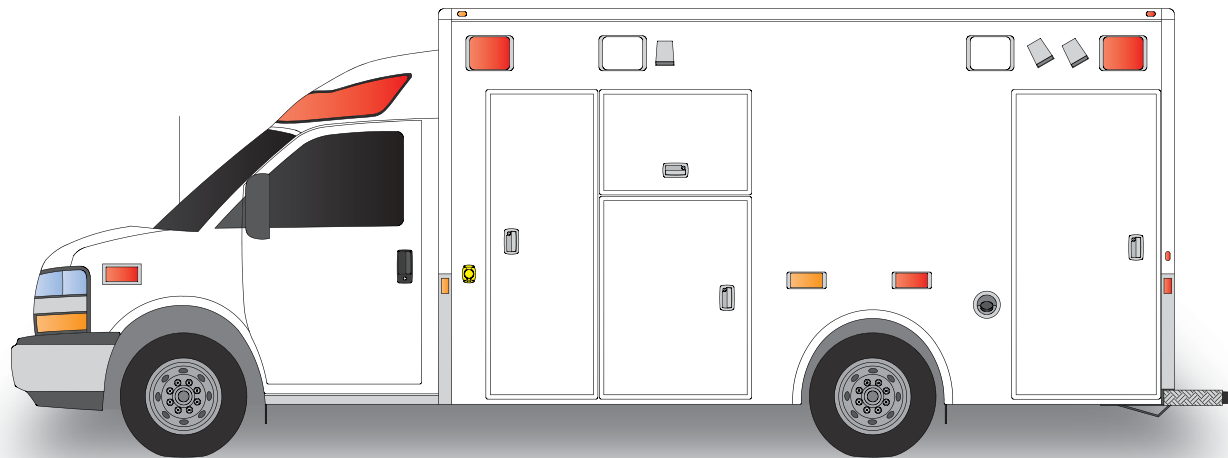
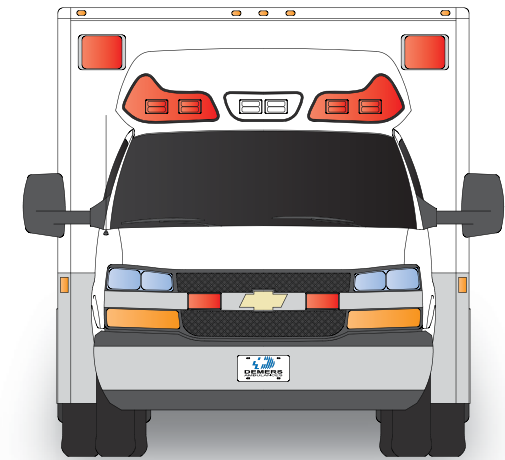
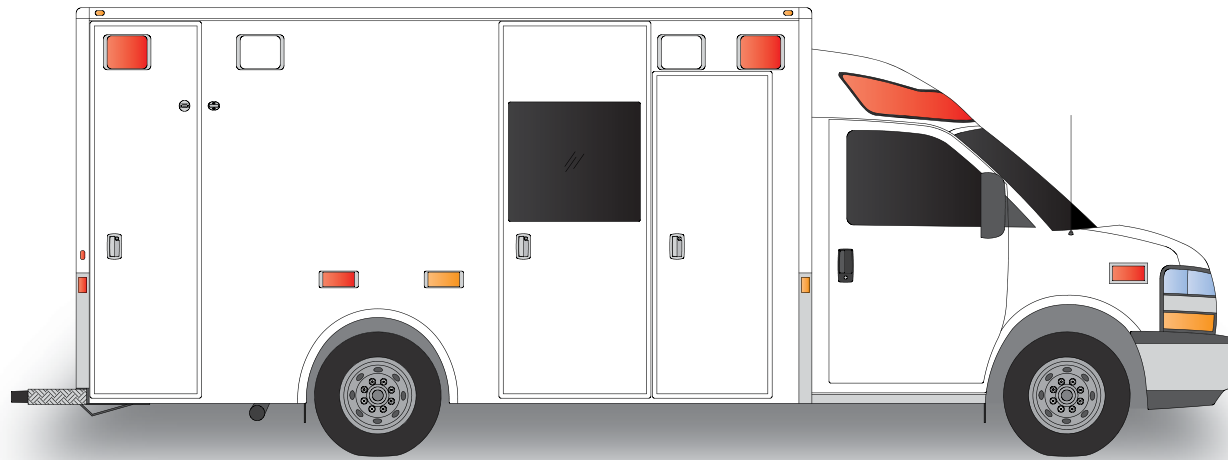

DIMENSIONAL DATA FOR INFORMATION ONLY. DRAWINGS MAY SHOW SOME OPTIONS.



DESCRIPTION : TYPE III --- GENERAL EXTERIOR				DRAWING NO.	
CONTRACT		CHASSIS	MODEL	DESIGNER :	
MX170E		CHEVROLET	G4500	BENOIT LANDRY	
2014		SCALE	PAGE	SALES :	REV.: 0
		1 : 45	2 / 37	DEMERS AMBULANCES	
				DEALER :	DATE: 2014-01-21
					MODULE NO. B800618

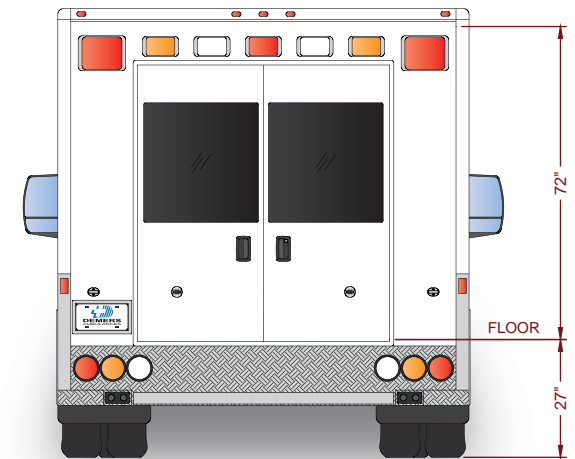
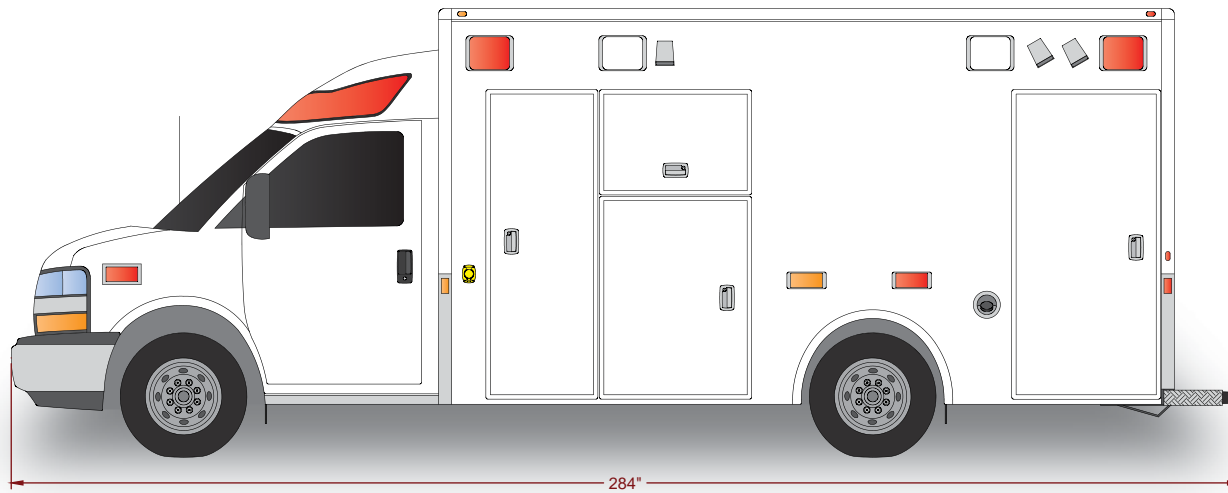
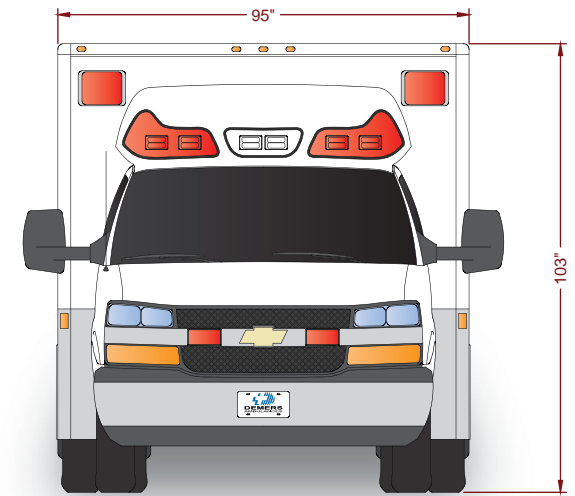
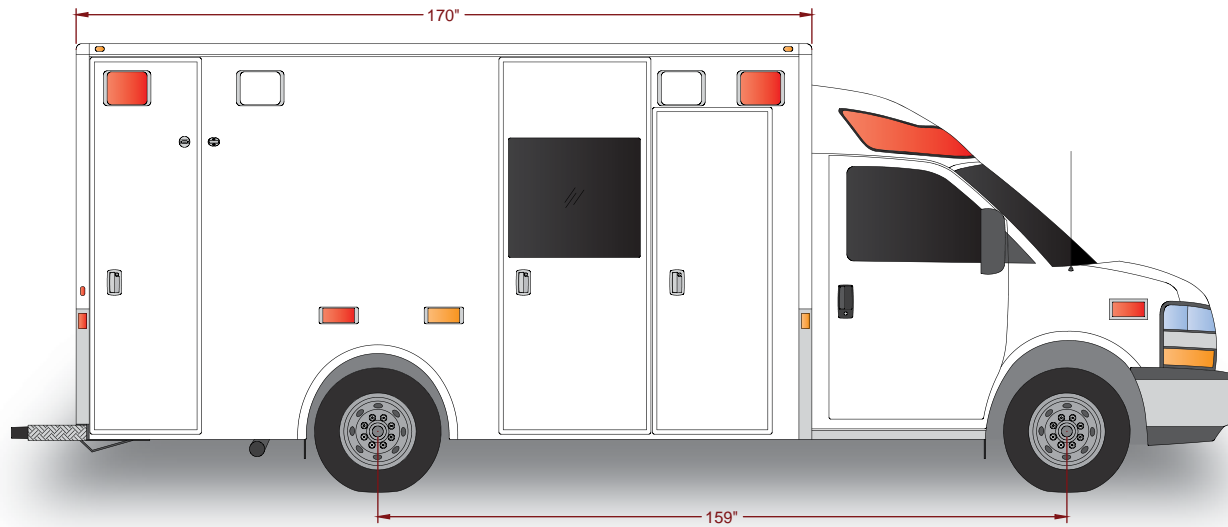

NOTE

THE TOTAL HEIGHT OF THE VEHICLE AND THE LOADING HEIGHT CAN BE DIFFERENT ACCORDING TO CHASSIS AND SUSPENSIONS

DIMENSIONAL DATA FOR INFORMATION ONLY. DRAWINGS MAY SHOW SOME OPTIONS.

 <p>DEMERS AMBULANCES www.demers-ambulances.com</p>	DESCRIPTION : TYPE III --- EXTERIOR DIMENSIONS			DRAWING NO.	
	CONTRACT	CHASSIS	MODEL	DESIGNER :	
			SCALE	PAGE	SALES :
	MX170E	CHEVROLET	G4500	BENOIT LANDRY	
2014	1 : 45	3 / 37	DEALER :		REV.: 0 DATE: 2014-01-21
					MODULE NO. B800618

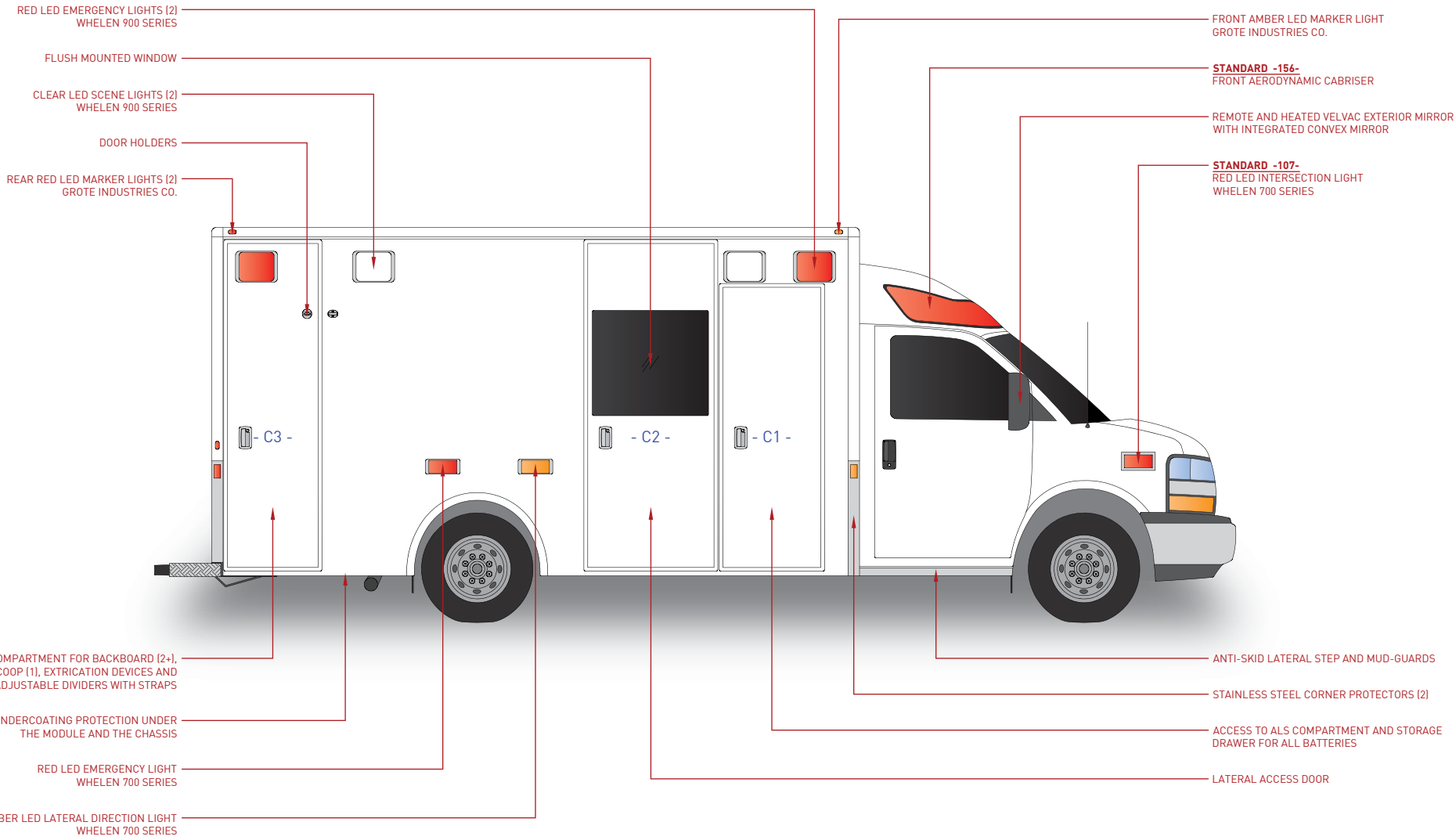

DIMENSIONAL DATA FOR INFORMATION ONLY. DRAWINGS MAY SHOW SOME OPTIONS.

COMPARTMENT	DIMENSIONS L x H x D
C1	23.25" x 56.50" x 31.25"
C3	22.75" x 80.25" x 18.75"



DESCRIPTION : TYPE III --- CURBSIDE EXTERIOR - STANDARD				DRAWING NO.	
CONTRACT	CHASSIS	MODEL	DESIGNER :	31GM-G4500XX-C4-0312	
MX170E	CHEVROLET	G4500	BENOIT LANDRY		
2014	SCALE	PAGE	SALES :	REV.: 0	DATE: 2014-01-21
	1 : 40	4 / 37	DEMERS AMBULANCES		
			DEALER :	MODULE NO. B800618	

OPTION -918-
ADDITIONAL RED LED EMERGENCY LIGHT
WHELEN 900 SERIES

OPTION -044-
ULTRA SOUND WHISTLE

OPTION -TBD-
ADDITIONAL FLUSH MOUNTED WINDOW
(W: 23.50" x H: 19.75")

OPTION -092-
FRONT LIGHT BAR

OPTION -106-
RED/CLEAR LED INTERSECTION LIGHT
WITH STEADY BURN, WHELEN 700 SERIES



OPTION -554-
RED LED LATERAL TAIL & TURN LIGHT
WHELEN 700 SERIES

OPTION -190-
ALUMINUM RUB-RAILS (2)

OPTION -722-
LUG NUT INDICATORS

OPTION -071-
CHROME WHEEL SIMULATORS

COMPARTMENT	DIMENSIONS L x H x D
C1	23.25" x 56.50" x 31.25"
C3	22.75" x 80.25" x 18.75"

DIMENSIONAL DATA FOR INFORMATION ONLY. DRAWINGS MAY SHOW SOME OPTIONS.



DESCRIPTION : TYPE III --- CURBSIDE EXTERIOR - OPTION				DRAWING NO.	
CONTRACT	CHASSIS	MODEL	DESIGNER :	31GM-G4500XX-C4-0313	
MX170E	CHEVROLET	G4500	BENOIT LANDRY		
2014	SCALE	PAGE	SALES :	REV.: 0	DATE: 2014-01-21
	1 : 40	5 / 37	DEMERS AMBULANCES		
			DEALER :	MODULE NO. B800618	

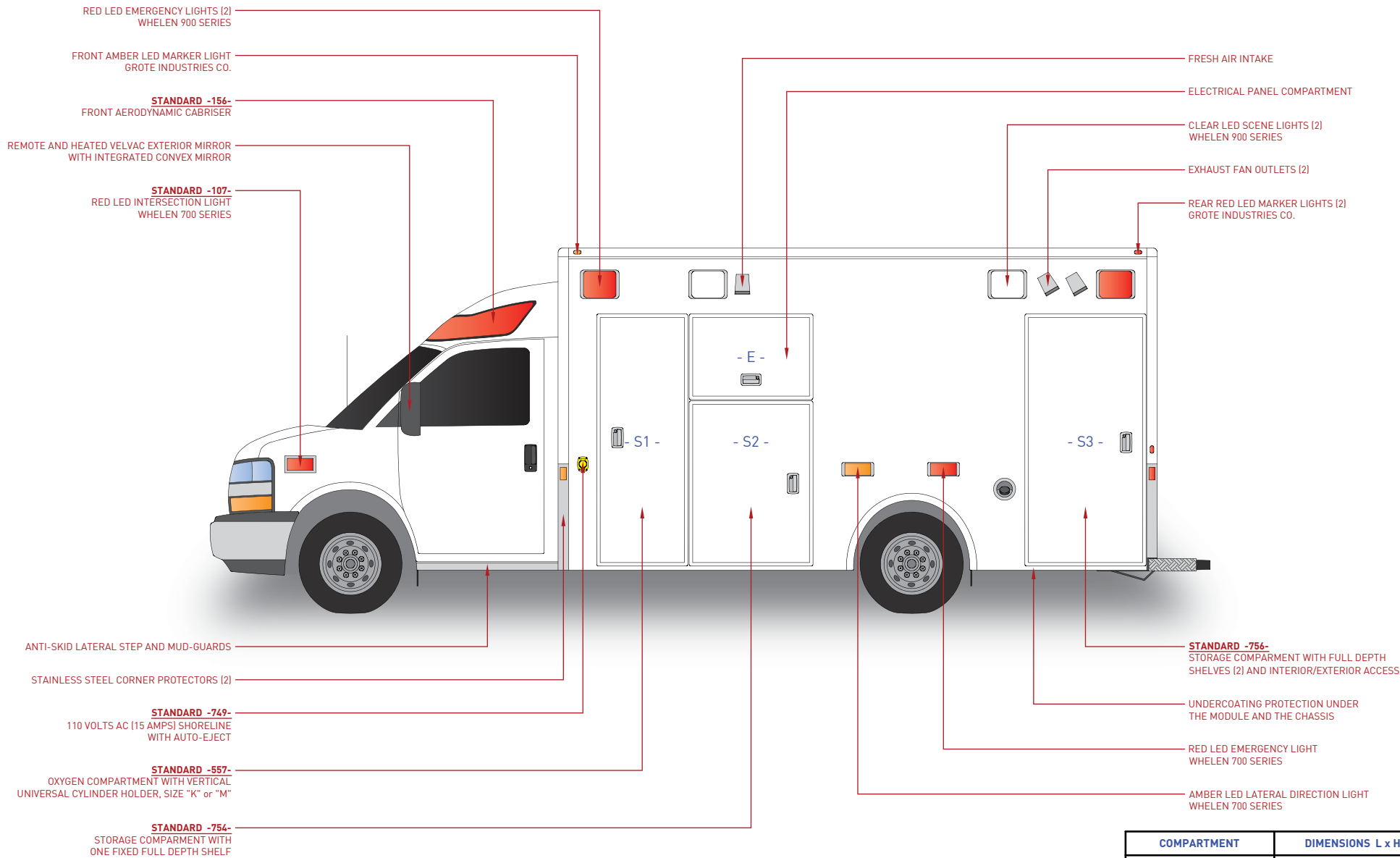

COMPARTMENT	DIMENSIONS L x H x D
S1	23.50" x 74.50" x 18.50"
S2	32.00" x 41.50" x 13.50"
S3	30.75" x 41.00" x 16.00"

DIMENSIONAL DATA FOR INFORMATION ONLY. DRAWINGS MAY SHOW SOME OPTIONS.

 <p>DEMERS AMBULANCES www.demers-ambulances.com</p>	DESCRIPTION : TYPE III --- STREETSIDE EXTERIOR - STANDARD			DRAWING NO. 31GM-G4500XX-C4-0314	
	CONTRACT MX170E 2014	CHASSIS CHEVROLET	MODEL G4500	DESIGNER : BENOIT LANDRY	
		SCALE 1 : 40	PAGE 6 / 37	SALES : DEMERS AMBULANCES	
				DEALER :	REV.: 0 DATE: 2014-01-21
				MODULE NO.	B800618

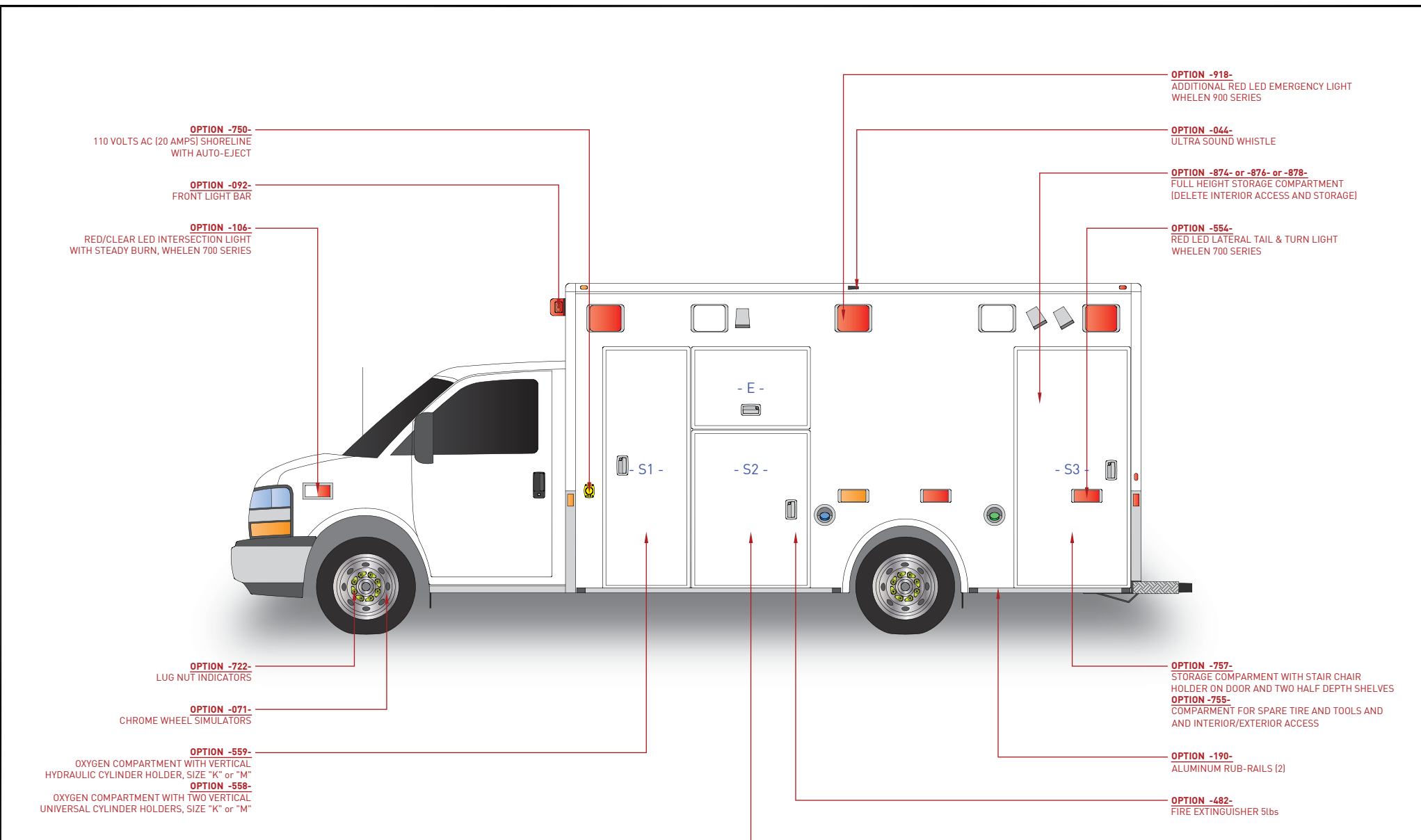

COMPARTMENT	DIMENSIONS L x H x D
S1	23.50" x 74.50" x 18.50"
S2	32.00" x 41.50" x 13.50"
S3	30.75" x 41.00" x 16.00"

DIMENSIONAL DATA FOR INFORMATION ONLY. DRAWINGS MAY SHOW SOME OPTIONS.

 <p>DEMERS AMBULANCES www.demers-ambulances.com</p>	DESCRIPTION : TYPE III --- STREETSIDE EXTERIOR - OPTION			DRAWING NO.	
	CONTRACT	CHASSIS	MODEL	DESIGNER :	
	MX170E	CHEVROLET	G4500	BENOIT LANDRY	
	2014	SCALE	PAGE	SALES :	REV.: 0
	1 : 40	7 / 37	DEALER :		MODULE NO. B800618

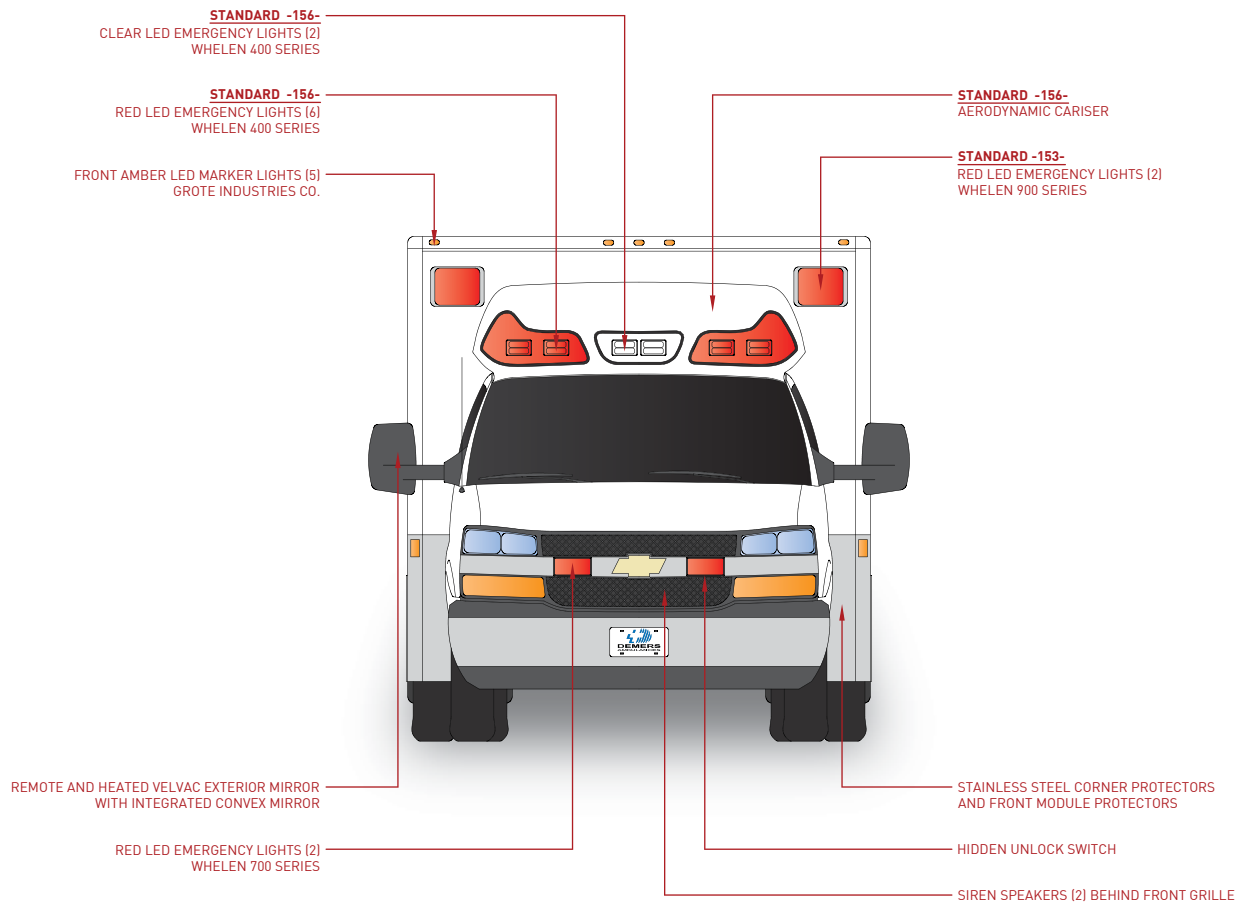

DIMENSIONAL DATA FOR INFORMATION ONLY. DRAWINGS MAY SHOW SOME OPTIONS.

 <p>DEMERS AMBULANCES www.demers-ambulances.com</p>	DESCRIPTION : TYPE III --- FRONT EXTERIOR - STANDARD			DRAWING NO.	
	CONTRACT	CHASSIS	MODEL	DESIGNER :	
		CHEVROLET	G4500	BENOIT LANDRY	
	MX170E	SCALE	PAGE	SALES :	REV.: 0
2014	1 : 40	8 / 37	DEMERS AMBULANCES		MODULE NO. B800618
			DEALER :		

OPTION -372-
AMBER LED ARROW LIGHTS (2)
WHELEN 600 SERIES

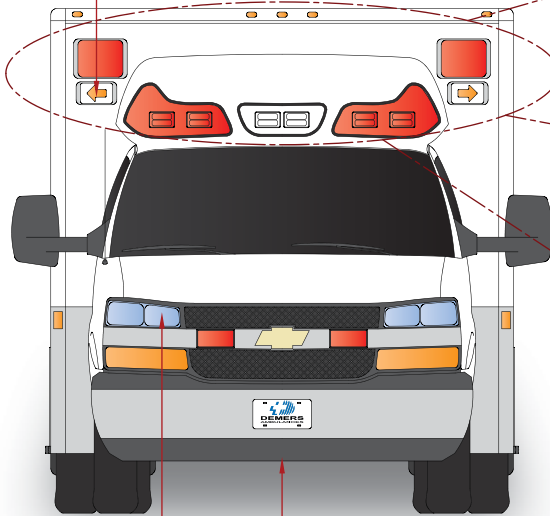

OPTION -589-
WIG-WAG LIGHTS IN OEM HEADLAMPS (2)

OPTION -TBD-
LOW FREQUENCY TONE SIREN

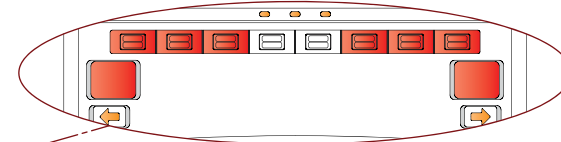

OPTION -092- and -154-
LIGHTBAR WITH RED (6) & CLEAR (2) LED LIGHTS
WHELEN 4500 PLUS SERIES &
RED (2) LED EMERGENCY LIGHTS
WHELEN 900 SERIES

OPTION -372-
AMBER LED ARROW TURNING LIGHTS (2)
WHELEN 600 SERIES

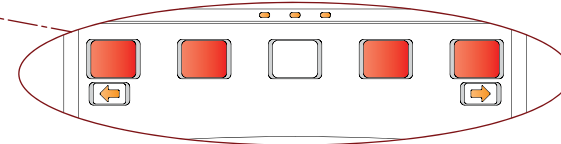

OPTION -914-
RED LED EMERGENCY LIGHTS (4)
WHELEN 900 SERIES
CLEAR LED EMERGENCY LIGHT (1)
WHELEN 900 SERIES

OPTION -372-
AMBER LED ARROW TURNING LIGHTS (2)
WHELEN 600 SERIES

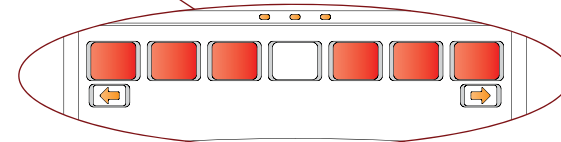

OPTION -915-
RED LED EMERGENCY LIGHTS (6)
WHELEN 900 SERIES
CLEAR LED EMERGENCY LIGHT (1)
WHELEN 900 SERIES

OPTION -372-
AMBER LED ARROW TURNING LIGHTS (2)
WHELEN 600 SERIES

DIMENSIONAL DATA FOR INFORMATION ONLY. DRAWINGS MAY SHOW SOME OPTIONS.

 <p>DEMERS AMBULANCES www.demers-ambulances.com</p>	DESCRIPTION : TYPE III --- FRONT EXTERIOR - OPTION				DRAWING NO.	
	CONTRACT		CHASSIS	MODEL	DESIGNER :	
	MX170E		CHEVROLET	G4500	BENOIT LANDRY	
	2014		SCALE	PAGE	SALES :	
		1 : 40	9 / 37	DEMERS AMBULANCES		REV.: 0 DATE: 2014-01-21
		DEALER :			MODULE NO. B800618	

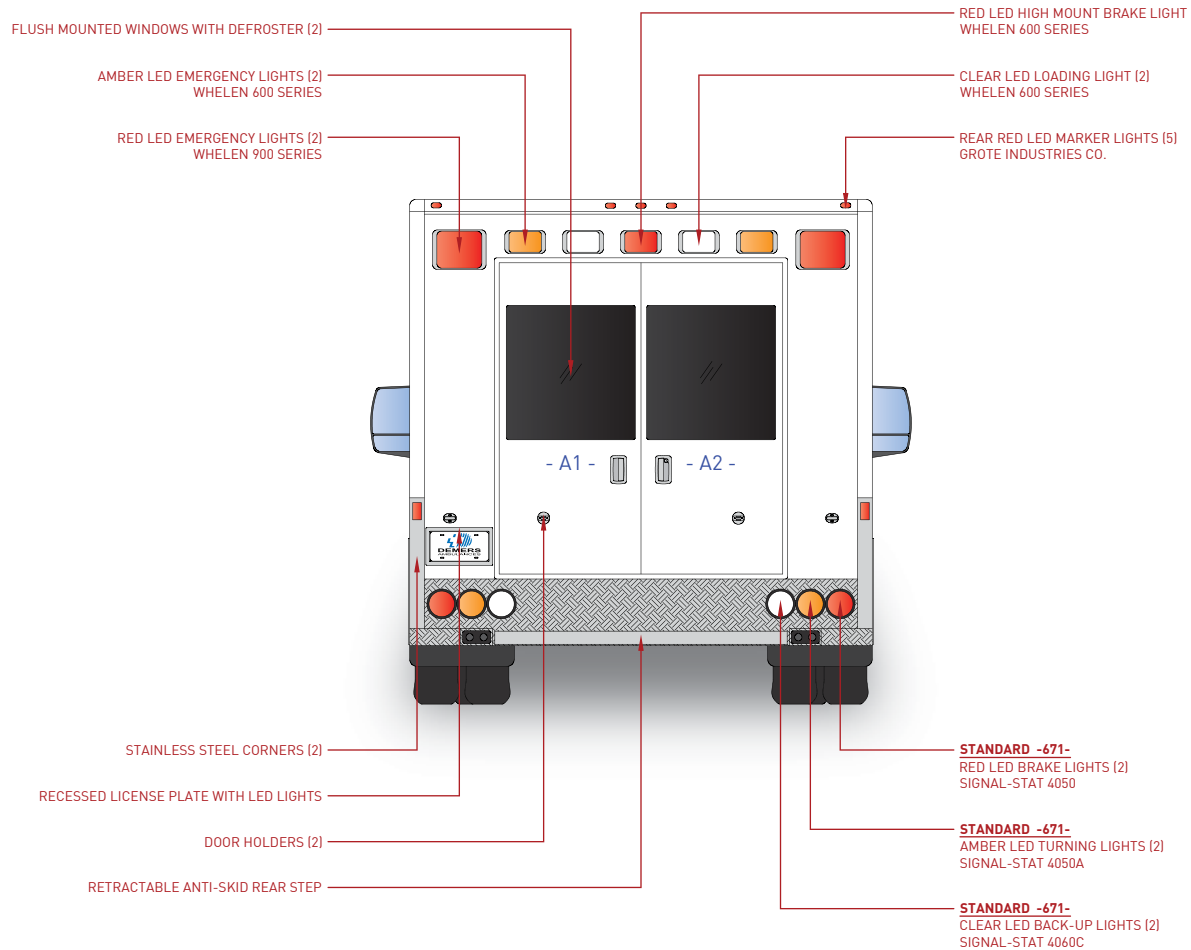

DIMENSIONAL DATA FOR INFORMATION ONLY. DRAWINGS MAY SHOW SOME OPTIONS.

 <p>DEMERS AMBULANCES www.demers-ambulances.com</p>	DESCRIPTION : TYPE III --- REAR EXTERIOR - STANDARD			DRAWING NO.		
	CONTRACT MX170E 2014	CHASSIS CHEVROLET	MODEL G4500	DESIGNER : BENOIT LANDRY		31GM-G4500XX-C4-0318
		SCALE 1 : 40	PAGE 10 / 37	SALES : DEMERS AMBULANCES		REV.: 0 DATE: 2014-01-21
				DEALER :	MODULE NO. B800618	

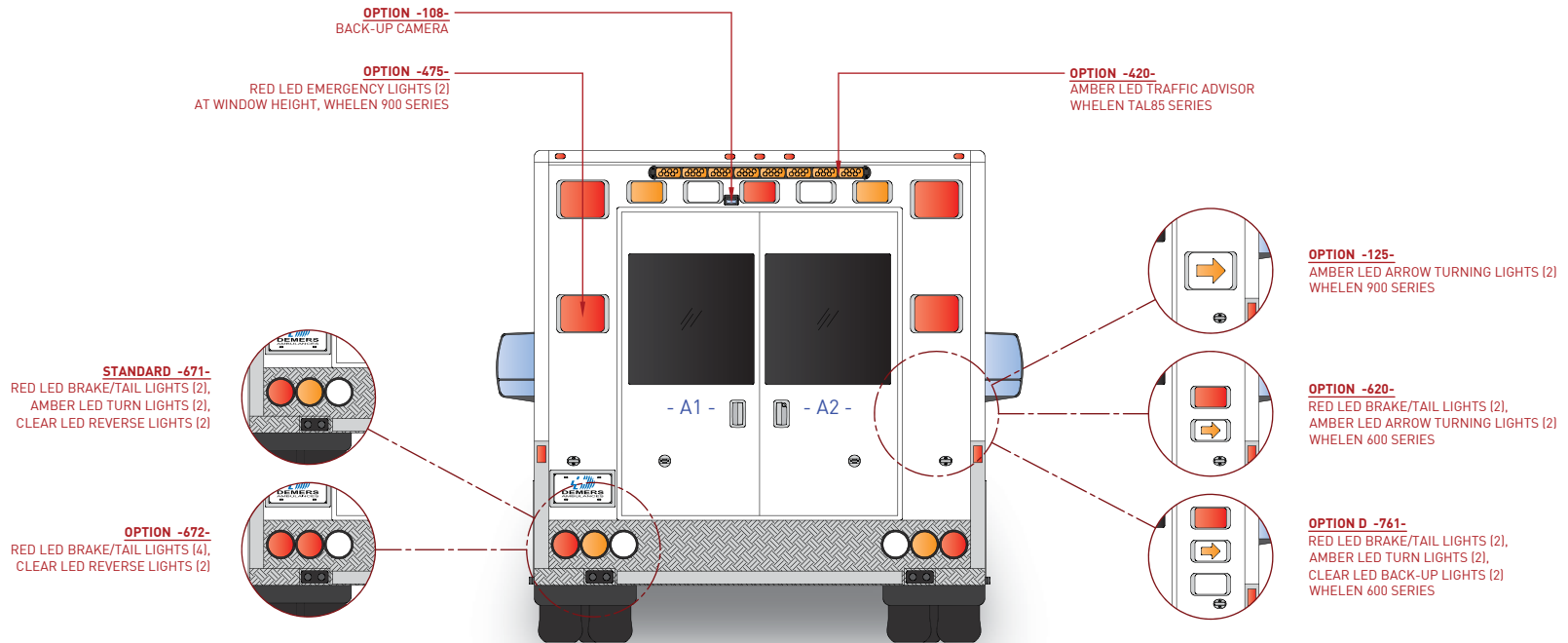

DIMENSIONAL DATA FOR INFORMATION ONLY. DRAWINGS MAY SHOW SOME OPTIONS.

 <p>DEMERS AMBULANCES www.demers-ambulances.com</p>	DESCRIPTION : TYPE III --- REAR EXTERIOR - OPTION				DRAWING NO.	
	CONTRACT		CHASSIS	MODEL	DESIGNER :	
	MX170E		CHEVROLET	G4500	BENOIT LANDRY	
	2014		SCALE	PAGE	SALES :	
		1 : 40	11 / 37	DEMERS AMBULANCES		REV.: 0
				DEALER :		DATE: 2014-01-21
						MODULE NO. B800618

STANDARD : 601

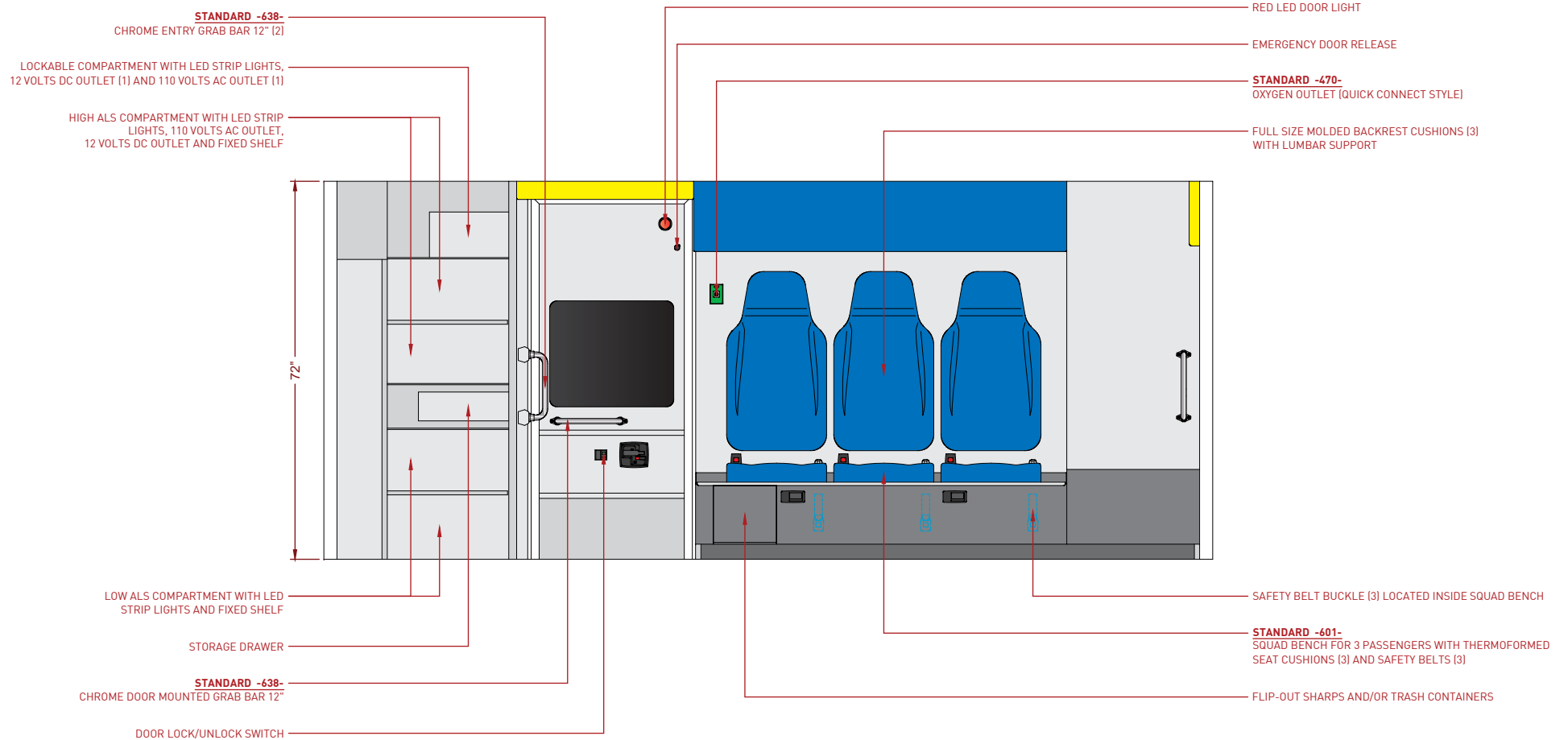

DIMENSIONAL DATA FOR INFORMATION ONLY. DRAWINGS MAY SHOW SOME OPTIONS.

 DEMERS AMBULANCES www.demers-ambulances.com	DESCRIPTION : TYPE III --- CURBSIDE WALL - SQUAD BENCH - STANDARD				DRAWING NO.	
	CONTRACT		CHASSIS	MODEL	DESIGNER :	
	MX170E		CHEVROLET	G4500	BENOIT LANDRY	
	2014		SCALE	PAGE	SALES :	
		1 : 30	12 / 37	DEMERS AMBULANCES		
				DEALER :		
				REV.: 0	DATE: 2014-01-21	
				MODULE NO. B800618		

OPTION : 798

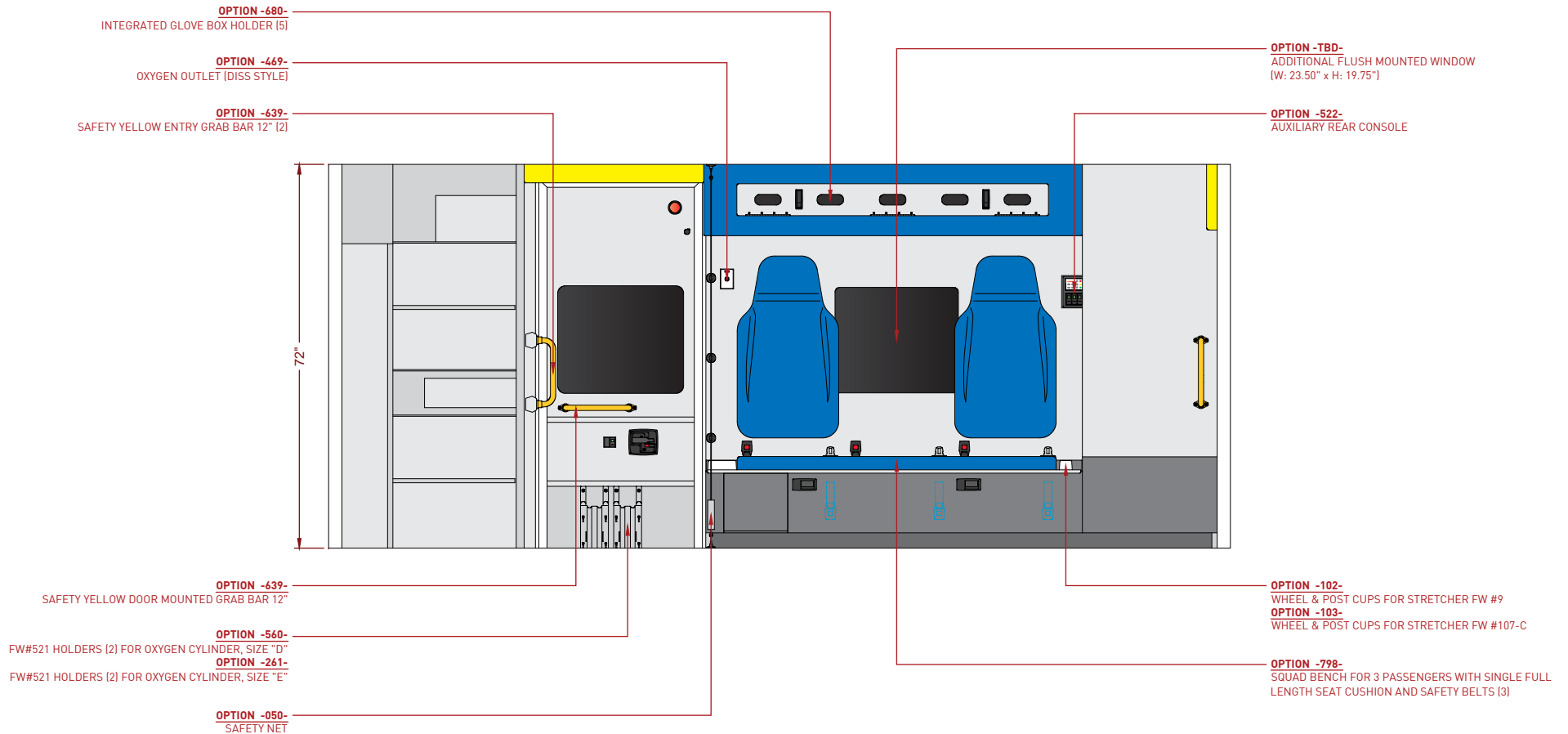

DIMENSIONAL DATA FOR INFORMATION ONLY. DRAWINGS MAY SHOW SOME OPTIONS.

 DEMERS AMBULANCES www.demers-ambulances.com	DESCRIPTION : TYPE III --- CURBSIDE WALL - SQUAD BENCH - OPTION			DRAWING NO.		
	CONTRACT		CHASSIS	MODEL	DESIGNER :	
	MX170E		CHEVROLET	G4500	BENOIT LANDRY	
	2014		SCALE	PAGE	SALES :	
		1 : 30	13 / 37	DEMERS AMBULANCES		
					REV.: 0	DATE: 2014-01-21
					DEALER :	
					MODULE NO. B800618	

OPTION : 712 & 794

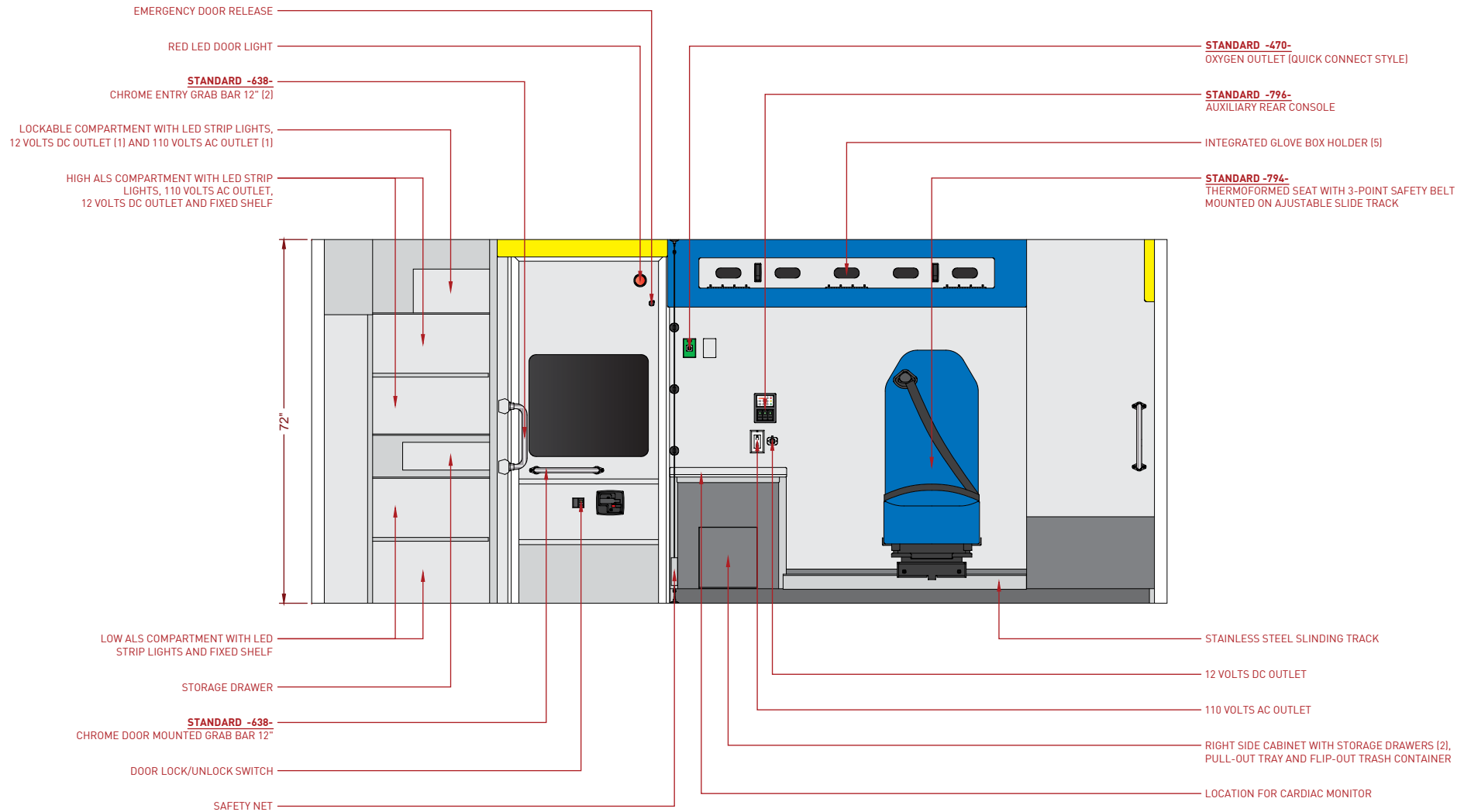

DIMENSIONAL DATA FOR INFORMATION ONLY. DRAWINGS MAY SHOW SOME OPTIONS.

 DEMERS AMBULANCES www.demers-ambulances.com	DESCRIPTION : TYPE III --- CURBSIDE WALL - MOBILITY SEAT				DRAWING NO.	
	CONTRACT		CHASSIS	MODEL	DESIGNER :	
	MX170E		CHEVROLET	G4500	BENOIT LANDRY	
	2014		SCALE	PAGE	SALES :	
		1 : 30	14 / 37	DEMERS AMBULANCES		REV.: 0
				DEALER :		DATE: 2014-01-21
						MODULE NO. B800618

OPTION : 712 & 794

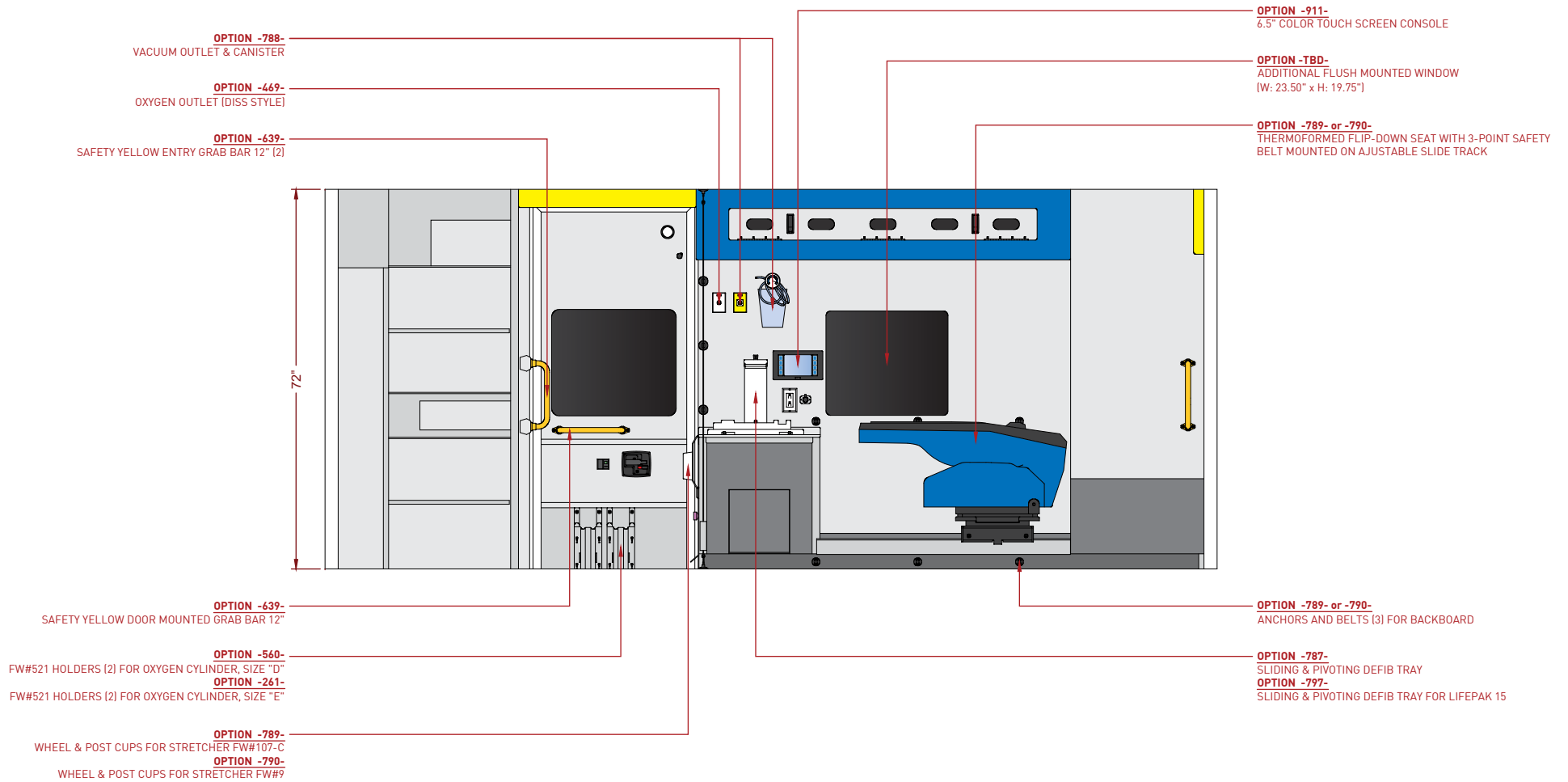

DIMENSIONAL DATA FOR INFORMATION ONLY. DRAWINGS MAY SHOW SOME OPTIONS.

 DEMERS AMBULANCES www.demers-ambulances.com	DESCRIPTION : TYPE III --- CURBSIDE WALL - MOBILITY SEAT - OPTION				DRAWING NO.	
	CONTRACT		CHASSIS	MODEL	DESIGNER :	
	MX170E		CHEVROLET	G4500	BENOIT LANDRY	
	2014		SCALE	PAGE	SALES :	
		1 : 30	15 / 37	DEMERS AMBULANCES		REV.: 0
				DEALER :		DATE: 2014-01-21
						MODULE NO. B800618

OPTION : 882

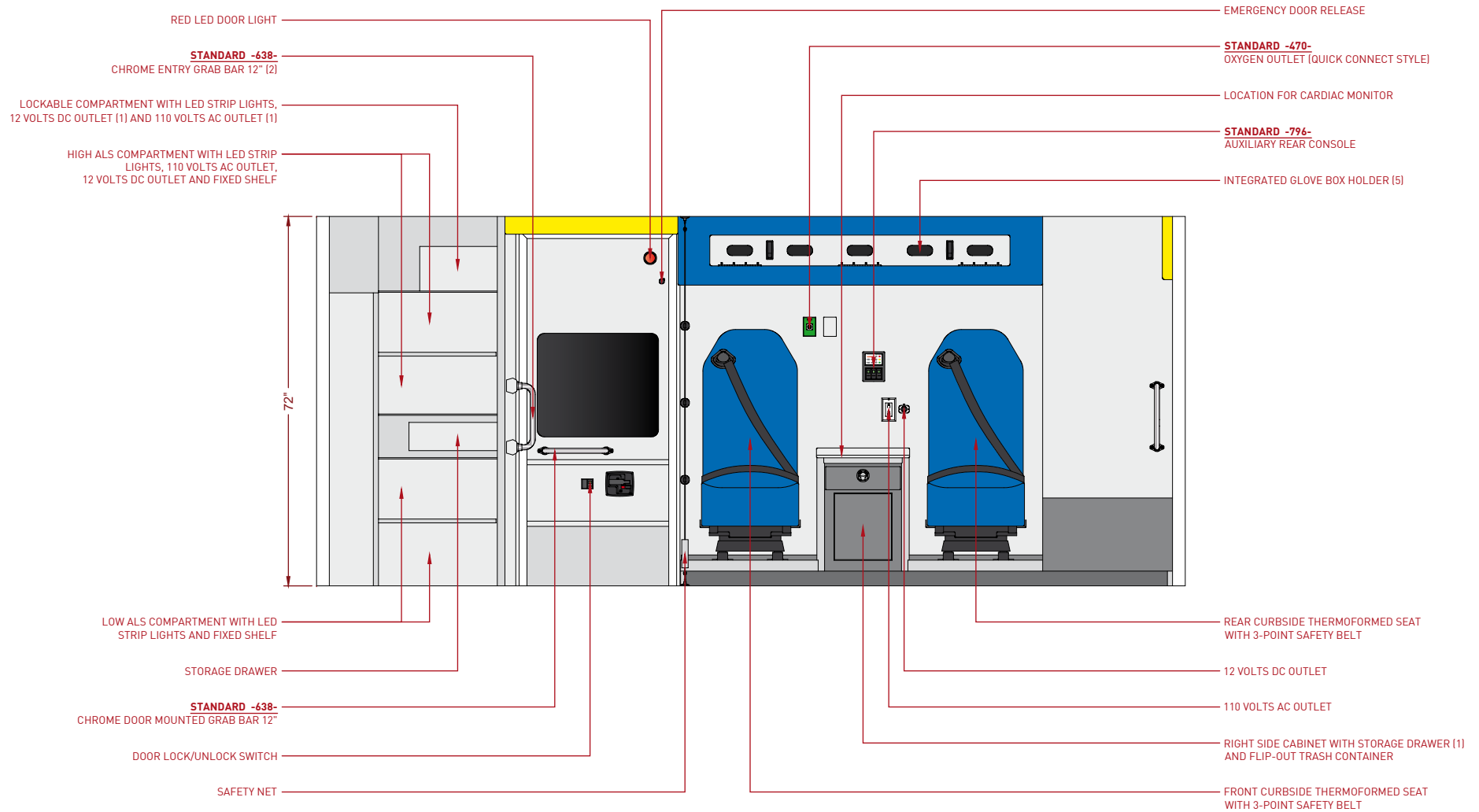

DIMENSIONAL DATA FOR INFORMATION ONLY. DRAWINGS MAY SHOW SOME OPTIONS.

 DEMERS AMBULANCES www.demers-ambulances.com	DESCRIPTION : TYPE III --- CURBSIDE WALL - DUAL CAPTAIN SEAT				DRAWING NO.	
	CONTRACT		CHASSIS	MODEL	DESIGNER :	
	MX170E		CHEVROLET	G4500	BENOIT LANDRY	
	2014		SCALE	PAGE	SALES :	
		1 : 30	16 / 37	DEMERS AMBULANCES		REV.: 0
				DEALER :		DATE: 2014-01-21
						MODULE NO. B800618

OPTION : 882

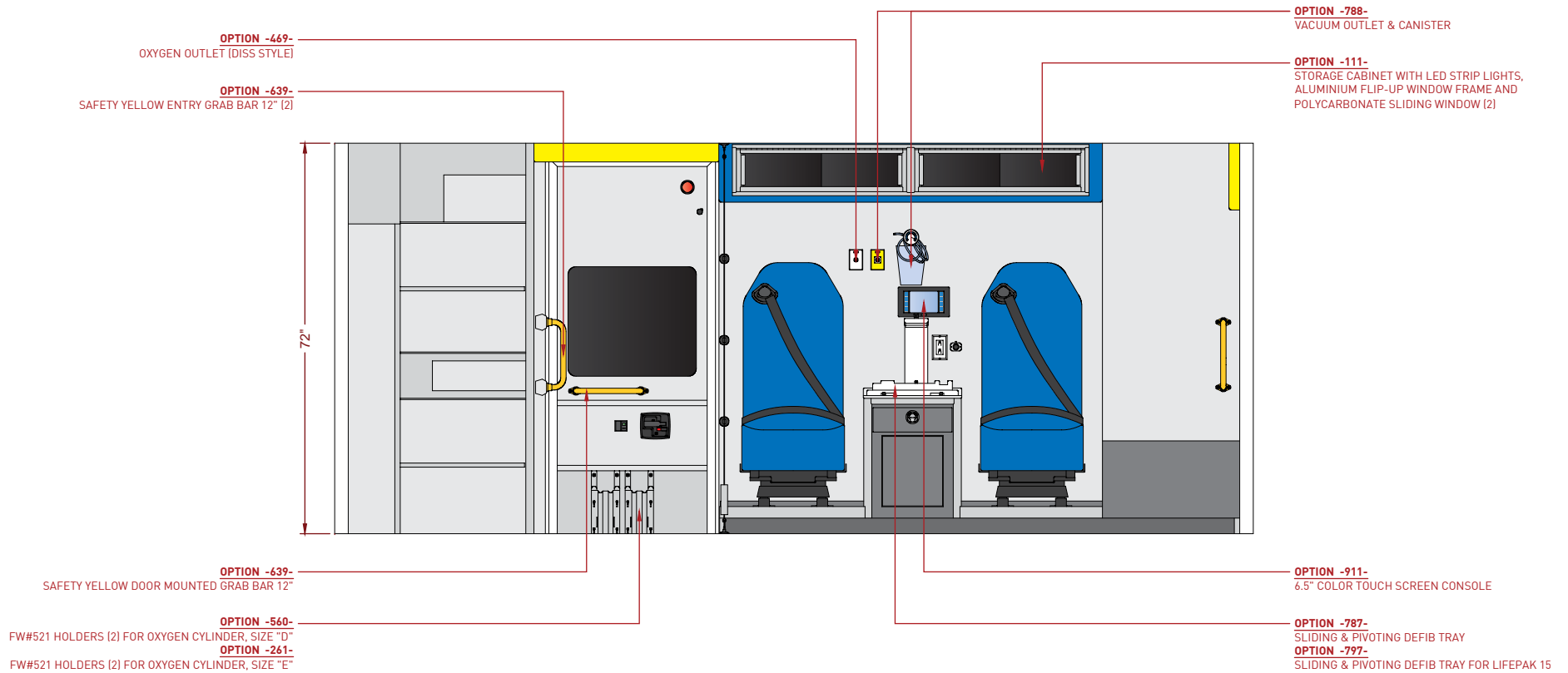

DIMENSIONAL DATA FOR INFORMATION ONLY. DRAWINGS MAY SHOW SOME OPTIONS.

COMPARTMENT	DIMENSIONS L x H x D
HIGH COMPARTMENT (2)	33.25" x 9.50" x 9.25"

 DEMERS AMBULANCES www.demers-ambulances.com	DESCRIPTION : TYPE III --- CURBSIDE WALL - DUAL CAPTAIN SEAT - OPTION			DRAWING NO.	
	CONTRACT	CHASSIS	MODEL	DESIGNER :	31GM-G4500XX-C4-0325
	MX170E	CHEVROLET	G4500	BENOIT LANDRY	
	2014	SCALE	PAGE	SALES :	REV.: 0 DATE: 2014-01-21
	1 : 30	17 / 37	DEALER :	MODULE NO. B800618	

STANDARD : 873

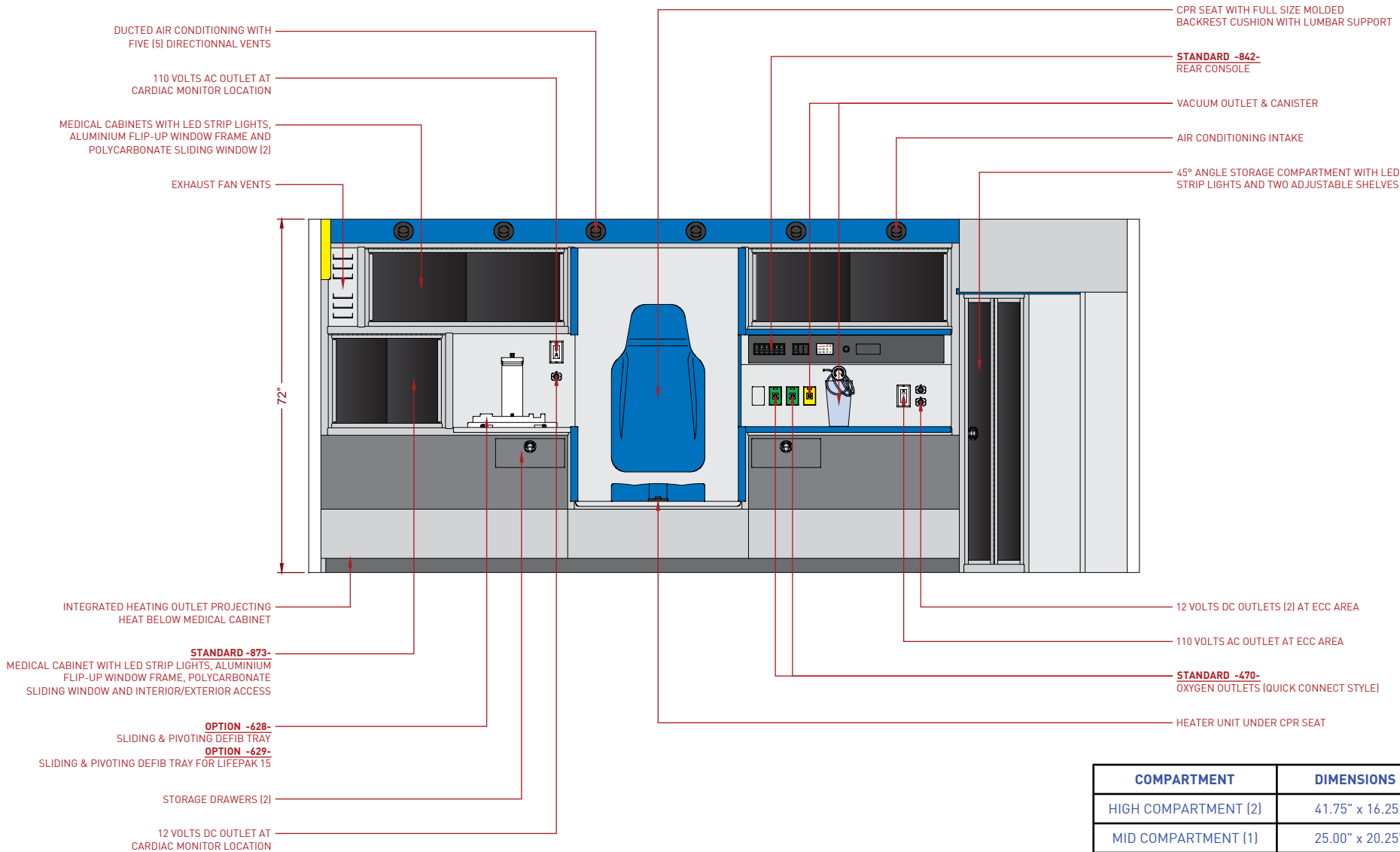

COMPARTMENT	DIMENSIONS L x H x D
HIGH COMPARTMENT (2)	41.75" x 16.25" x 10.25"
MID COMPARTMENT (1)	25.00" x 20.25" x 15.00"
45° COMPARTMENT (1)	21.50" x 57.25" x 15.75"
DRAWER (2)	12.00" x 4.75" x 12.50"

DIMENSIONAL DATA FOR INFORMATION ONLY. DRAWINGS MAY SHOW SOME OPTIONS.

 <p>DEMERS AMBULANCES www.demers-ambulances.com</p>	DESCRIPTION : TYPE III --- STREETSIDE WALL - CPR SEAT - STANDARD			DRAWING NO.	
	CONTRACT	CHASSIS	MODEL	DESIGNER :	31GM-G4500XX-C4-0326
	MX170E	CHEVROLET	G4500	BENOIT LANDRY	
	2014	SCALE	PAGE	SALES :	REV.: 0 DATE: 2014-01-21
	1 : 30	18 / 37	DEALER :	MODULE NO. B800618	

OPTION : 874

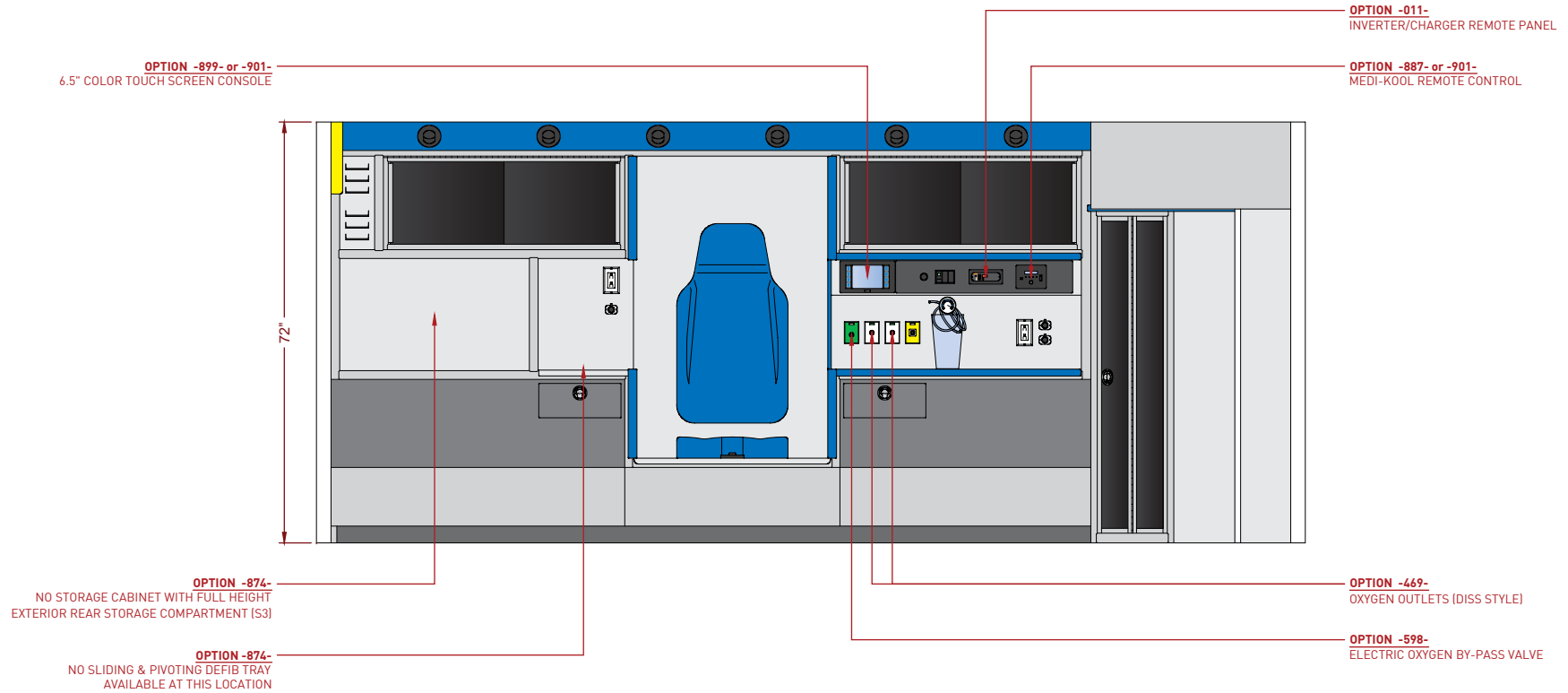

COMPARTMENT	DIMENSIONS L x H x D
HIGH COMPARTMENT (2)	41.75" x 16.25" x 10.25"
45° COMPARTMENT (1)	21.50" x 57.25" x 15.75"
DRAWER (2)	12.00" x 4.75" x 12.50"

DIMENSIONAL DATA FOR INFORMATION ONLY. DRAWINGS MAY SHOW SOME OPTIONS.

 DEMERS AMBULANCES www.demers-ambulances.com	DESCRIPTION : TYPE III --- STREETSIDE WALL - CPR SEAT - OPTION				DRAWING NO.	
	CONTRACT		CHASSIS	MODEL	DESIGNER :	
	MX170E		CHEVROLET	G4500	BENOIT LANDRY	
	2014		SCALE	PAGE	SALES :	
		1 : 30	19 / 37	DEMERS AMBULANCES		REV.: 0
				DEALER :		DATE: 2014-01-21
						MODULE NO. B800618

OPTION : 875

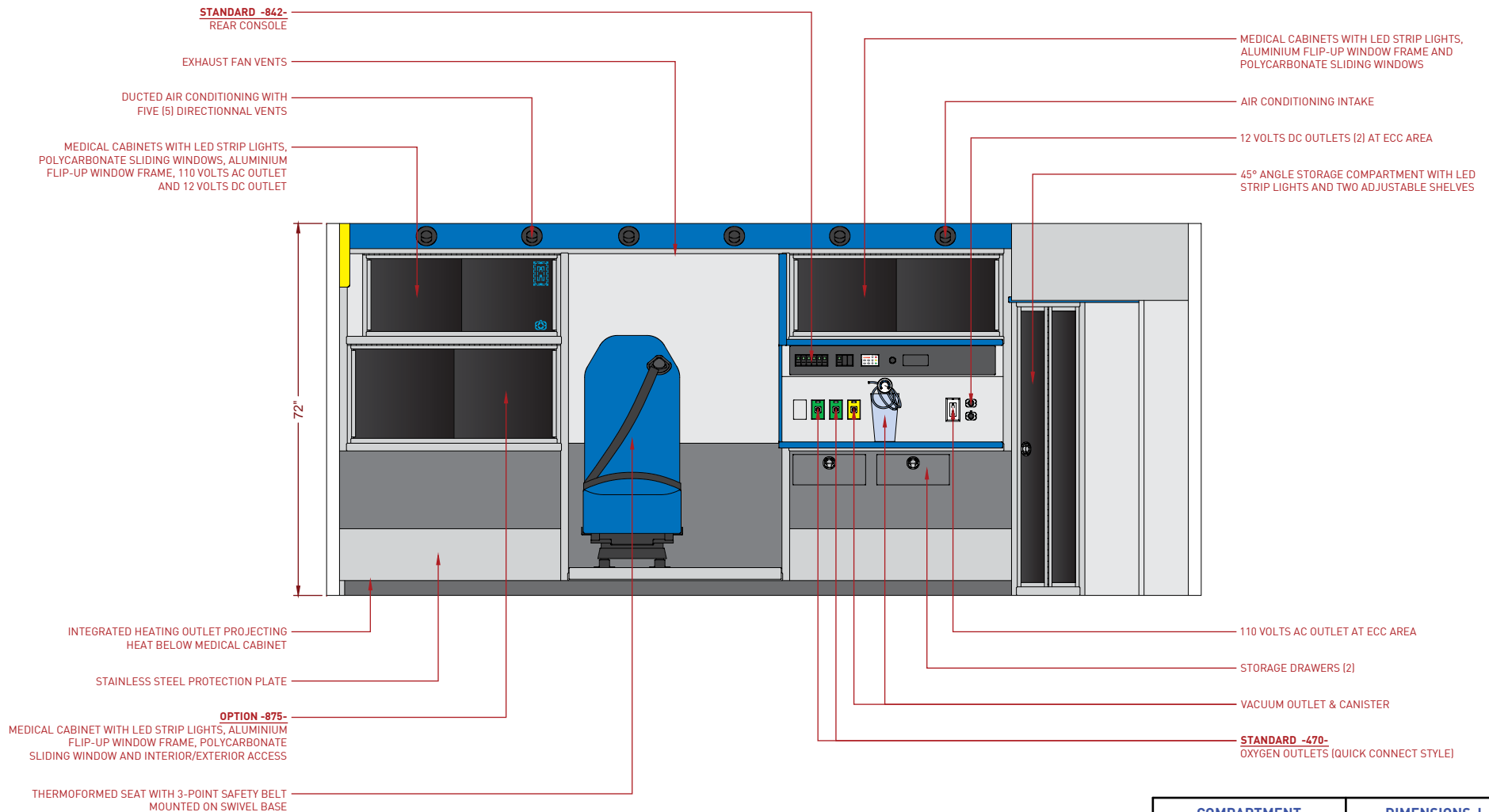

COMPARTMENT	DIMENSIONS L x H x D
HIGH COMPARTMENT (2)	41.75" x 16.25" x 10.25"
MID COMPARTMENT (1)	42.50" x 20.25" x 15.00"
45° COMPARTMENT (1)	21.50" x 57.25" x 15.75"
DRAWER (2)	12.00" x 4.75" x 12.50"

DIMENSIONAL DATA FOR INFORMATION ONLY. DRAWINGS MAY SHOW SOME OPTIONS.

 DEMERS AMBULANCES www.demers-ambulances.com	DESCRIPTION : TYPE III --- STREETSIDE WALL - CPR CAPTAIN SEAT			DRAWING NO.	
	CONTRACT	CHASSIS	MODEL	DESIGNER :	
	MX170E	CHEVROLET	G4500	BENOIT LANDRY	
	2014	SCALE	PAGE	SALES :	REV.: 0
	1 : 30	20 / 37	DEALER :		MODULE NO. B800618

OPTION : 876

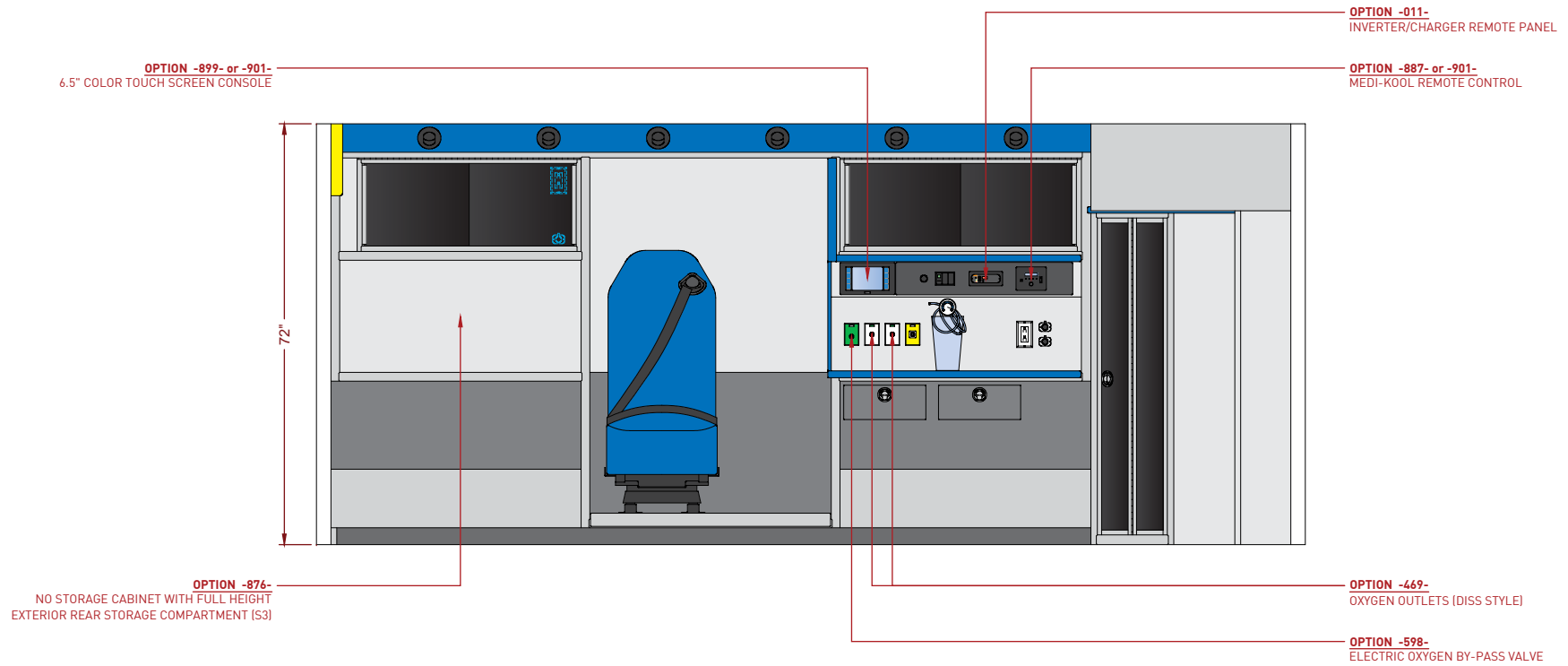

COMPARTMENT	DIMENSIONS L x H x D
HIGH COMPARTMENT (2)	41.75" x 16.25" x 10.25"
45° COMPARTMENT (1)	21.50" x 57.25" x 15.75"
DRAWER (2)	12.00" x 4.75" x 12.50"

DIMENSIONAL DATA FOR INFORMATION ONLY. DRAWINGS MAY SHOW SOME OPTIONS.

 DEMERS AMBULANCES www.demers-ambulances.com	DESCRIPTION : TYPE III --- STREETSIDE WALL - CPR CAPTAIN SEAT - OPTION			DRAWING NO.	
	CONTRACT	CHASSIS	MODEL	DESIGNER :	
	MX170E	CHEVROLET	G4500	BENOIT LANDRY	
	2014	SCALE	PAGE	SALES :	REV.: 0
	1 : 30	21 / 37	DEALER :		MODULE NO. B800618

OPTION : 877

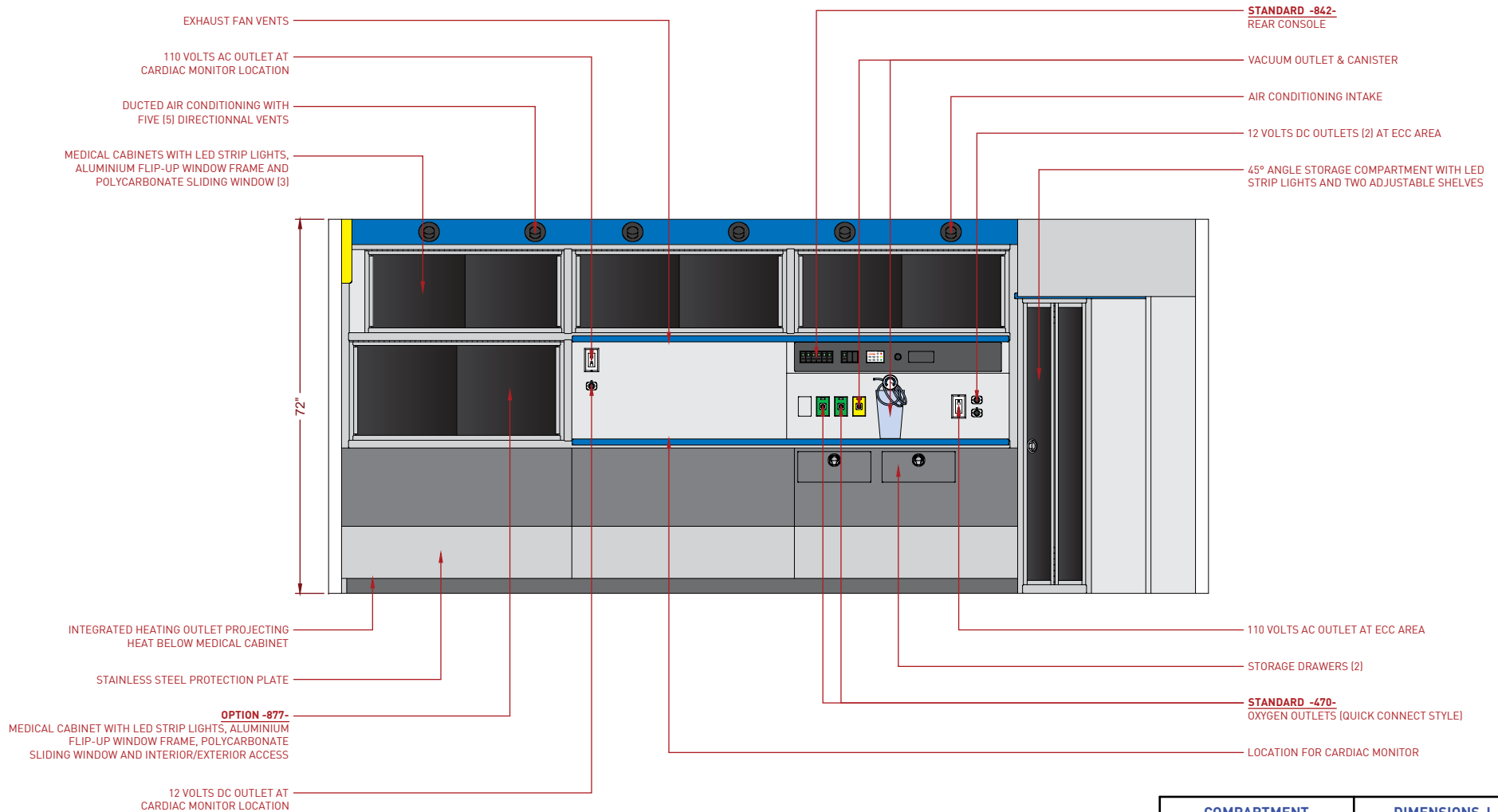

COMPARTMENT	DIMENSIONS L x H x D
HIGH COMPARTMENT (3)	41.75" x 16.25" x 10.25"
MID COMPARTMENT (1)	42.50" x 20.25" x 15.00"
45° COMPARTMENT (1)	21.50" x 57.25" x 15.75"
DRAWER (2)	12.00" x 4.75" x 12.50"

DIMENSIONAL DATA FOR INFORMATION ONLY. DRAWINGS MAY SHOW SOME OPTIONS.

 DEMERS AMBULANCES www.demers-ambulances.com	DESCRIPTION : TYPE III --- STREETSIDE WALL - FULL CABINET				DRAWING NO. 31GM-G4500XX-C4-0330	
	CONTRACT MX170E		CHASSIS CHEVROLET	MODEL G4500	DESIGNER : BENOIT LANDRY	
	2014		SCALE 1 : 30	PAGE 22 / 37	SALES : DEMERS AMBULANCES	
					DEALER :	
				REV.: 0		DATE: 2014-01-21
				MODULE NO. B800618		

OPTION : 878

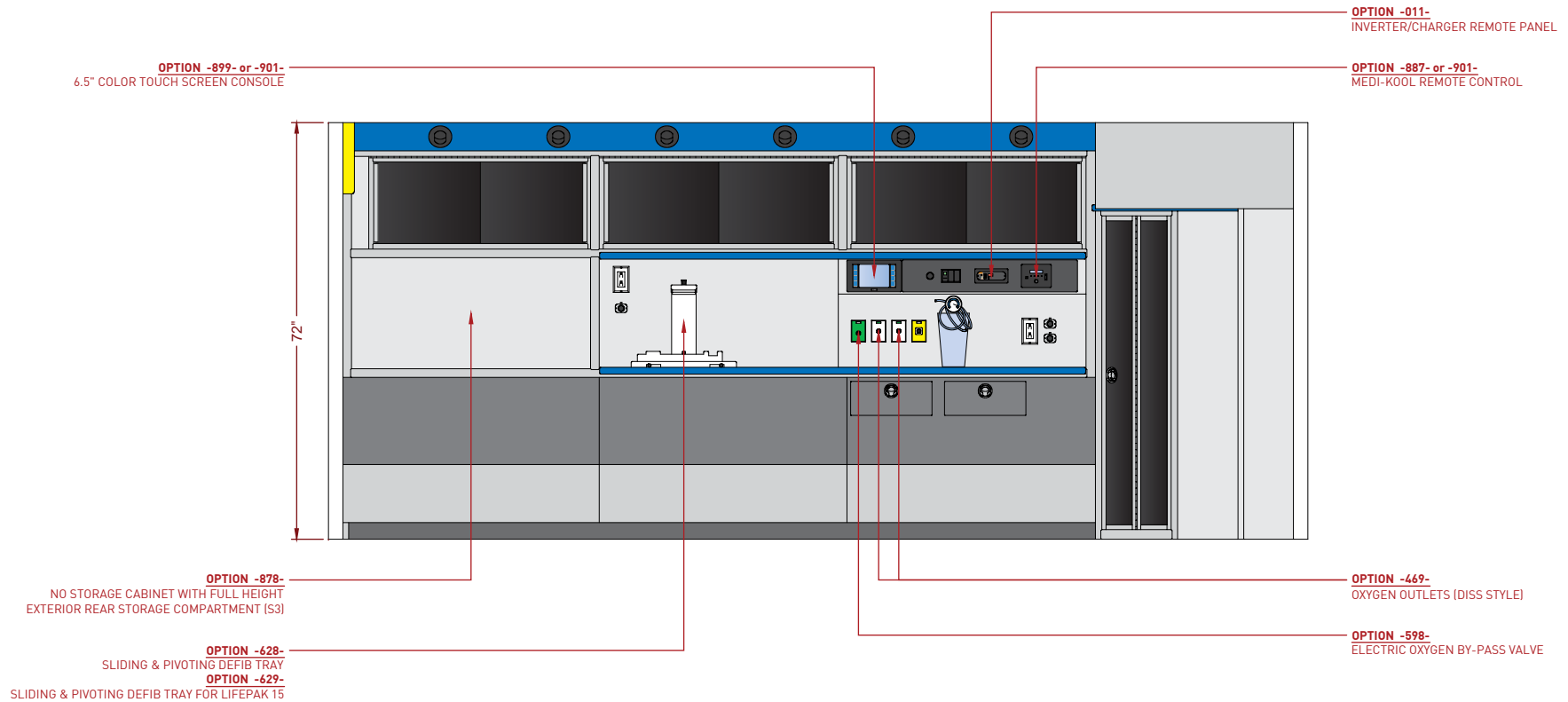

COMPARTMENT	DIMENSIONS L x H x D
HIGH COMPARTMENT (3)	41.75" x 16.25" x 10.25"
45° COMPARTMENT (1)	21.50" x 57.25" x 15.75"
DRAWER (2)	12.00" x 4.75" x 12.50"

DIMENSIONAL DATA FOR INFORMATION ONLY. DRAWINGS MAY SHOW SOME OPTIONS.

 DEMERS AMBULANCES www.demers-ambulances.com	DESCRIPTION : TYPE III --- STREETSIDE WALL - FULL CABINET - OPTION				DRAWING NO.	
	CONTRACT		CHASSIS	MODEL	DESIGNER :	
	MX170E		CHEVROLET	G4500	BENOIT LANDRY	
	2014		SCALE	PAGE	SALES :	
		1 : 30	23 / 37	DEMERS AMBULANCES		REV.: 0
				DEALER :		DATE: 2014-01-21
						MODULE NO. B800618

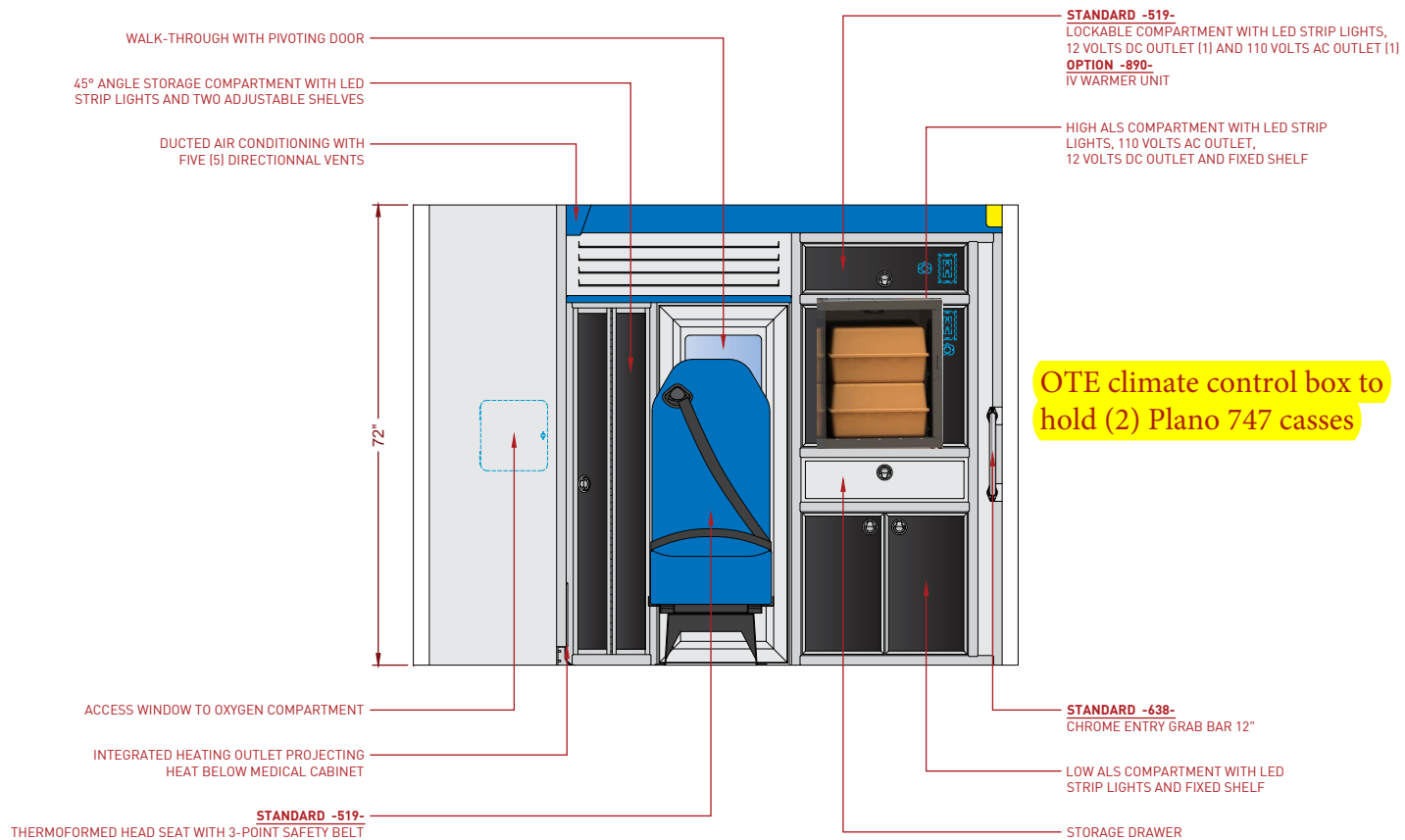

COMPARTMENT	DIMENSIONS L x H x D
IV WARMER COMP.	26.00" x 8.00" x 13.75"
HIGH ALS COMPARTMENT	31.75" x 23.00" x 23.25"
DRAWER	21.75" x 4.25" x 18.25"
LOW ALS COMPARTMENT	31.75" x 24.25" x 23.25"

DIMENSIONAL DATA FOR INFORMATION ONLY. DRAWINGS MAY SHOW SOME OPTIONS.

 <p>DEMERS AMBULANCES www.demers-ambulances.com</p>	DESCRIPTION : TYPE III --- FRONT WALL - STANDARD				DRAWING NO. 31GM-G4500XX-C4-0332		
	CONTRACT MX170E	CHASSIS CHEVROLET	MODEL G4500	DESIGNER : BENOIT LANDRY		REV.: 0	DATE: 2014-01-21
	2014	SCALE 1 : 30	PAGE 24 / 37	SALES : DEMERS AMBULANCES			
					DEALER :		MODULE NO. B800618

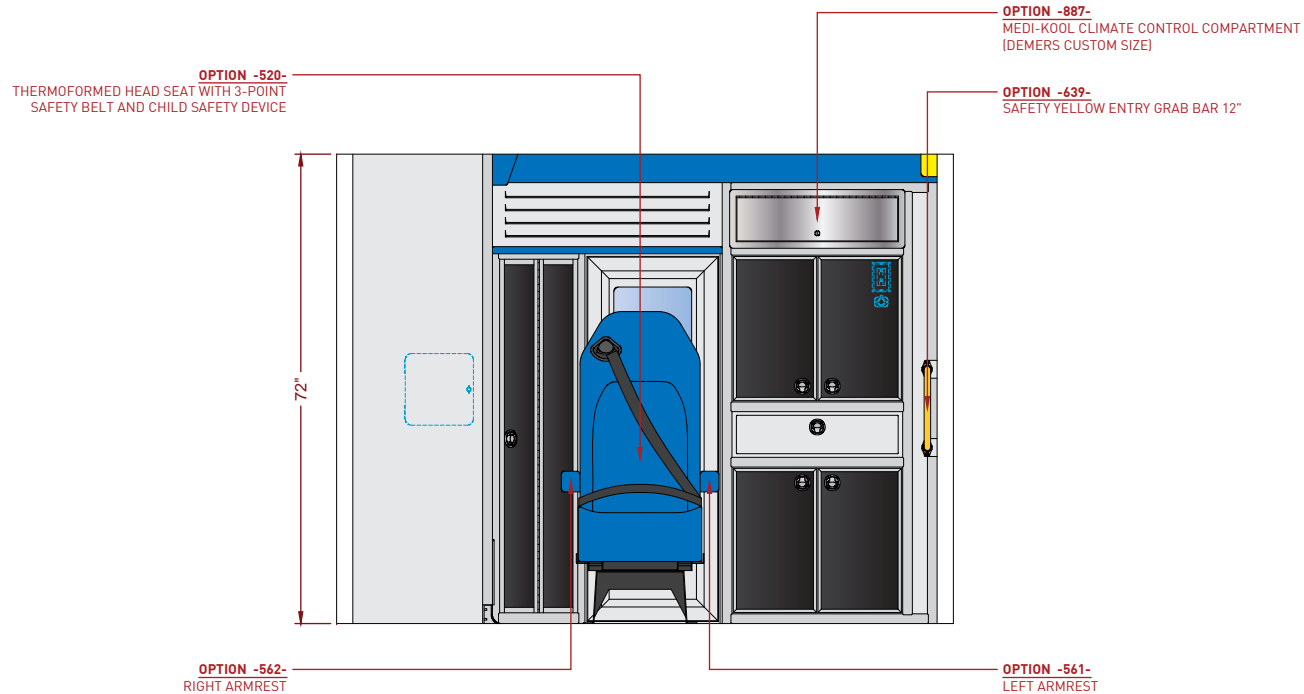

COMPARTMENT	DIMENSIONS L x H x D
HIGH ALS COMPARTMENT	31.75" x 23.00" x 23.25"
DRAWER	21.75" x 4.25" x 18.25"
LOW ALS COMPARTMENT	31.75" x 24.25" x 23.25"

DIMENSIONAL DATA FOR INFORMATION ONLY. DRAWINGS MAY SHOW SOME OPTIONS.

 <p>DEMERS AMBULANCES www.demers-ambulances.com</p>	DESCRIPTION : TYPE III --- FRONT WALL - OPTION				DRAWING NO.	
	CONTRACT		CHASSIS	MODEL	DESIGNER :	
	MX170E		CHEVROLET	G4500	BENOIT LANDRY	
	2014		SCALE	PAGE	SALES :	
		1 : 30	25 / 37	DEMERS AMBULANCES		REV.: 0
				DEALER :		DATE: 2014-01-21
						MODULE NO. B800618

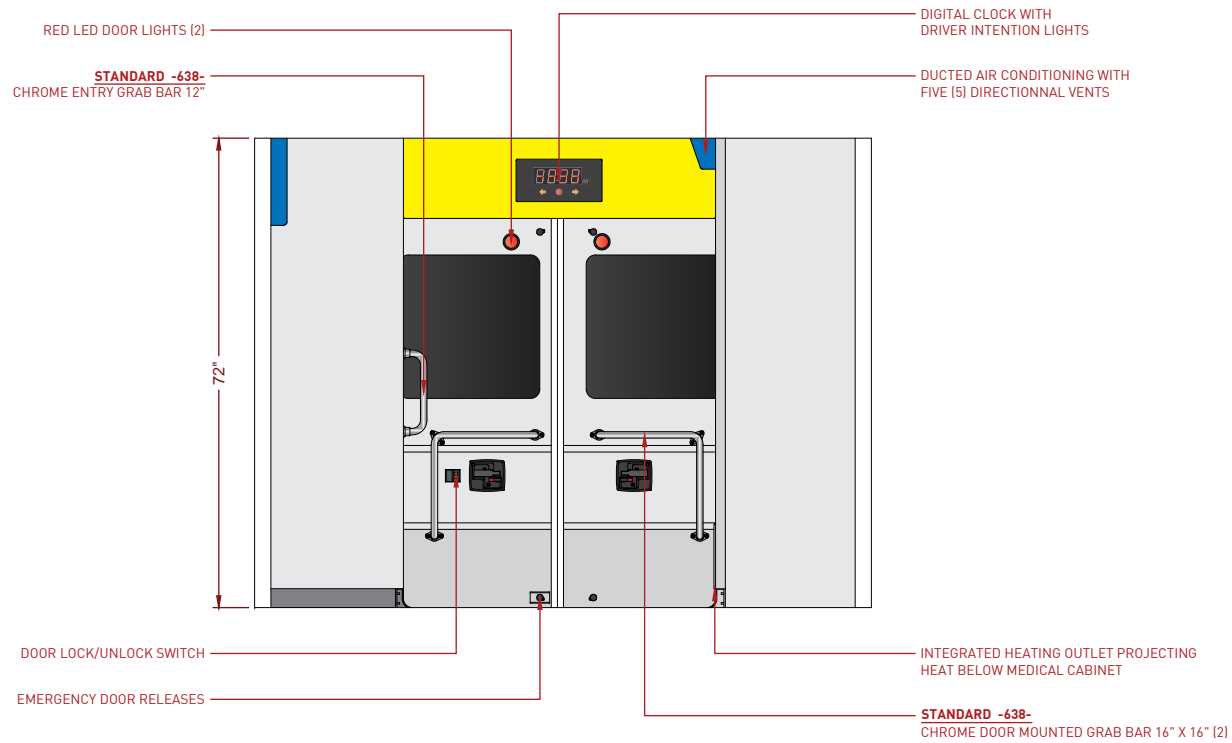

DIMENSIONAL DATA FOR INFORMATION ONLY. DRAWINGS MAY SHOW SOME OPTIONS.

 <p>DEMERS AMBULANCES www.demers-ambulances.com</p>	DESCRIPTION : TYPE III --- REAR WALL - STANDARD			DRAWING NO.	
	CONTRACT	CHASSIS	MODEL	DESIGNER :	
		CHEVROLET	G4500	BENOIT LANDRY	
	MX170E	SCALE	PAGE	SALES :	REV.: 0
2014		1 : 30	26 / 37	DEALER :	
			MODULE NO.		B800618

OPTION -639-
SAFETY YELLOW ENTRY GRAB BAR 12"

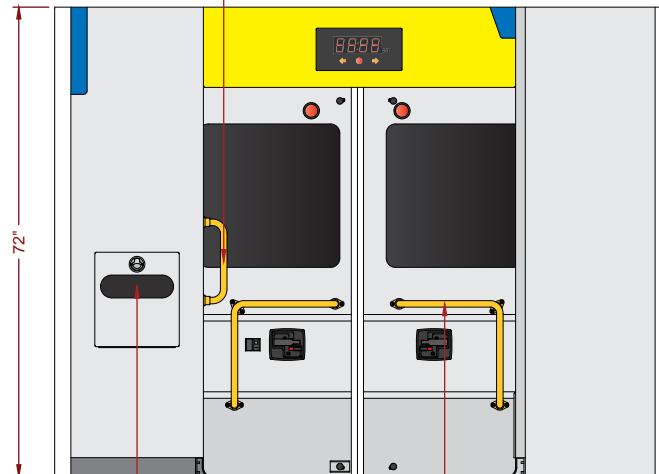

OPTION -879-
SHARPS CONTAINER ENCLOSED IN
BACKBOARD COMPARTMENT

OPTION -639-
SAFETY YELLOW DOOR MOUNTED
GRAB BAR 16" X 16" (2)

DIMENSIONAL DATA FOR INFORMATION ONLY. DRAWINGS MAY SHOW SOME OPTIONS.

 <p>DEMERS AMBULANCES www.demers-ambulances.com</p>	DESCRIPTION : TYPE III --- REAR WALL - OPTION			DRAWING NO.	
	CONTRACT	CHASSIS	MODEL	DESIGNER :	
				BENOIT LANDRY	
	MX170E	CHEVROLET	G4500	SALES :	REV.: 0
2014		SCALE	PAGE	DEALER :	
	1 : 30	27 / 37			MODULE NO. B800618

31GM-G4500XX-C4-0335

DATE: 2014-01-21

MODULE NO. B800618

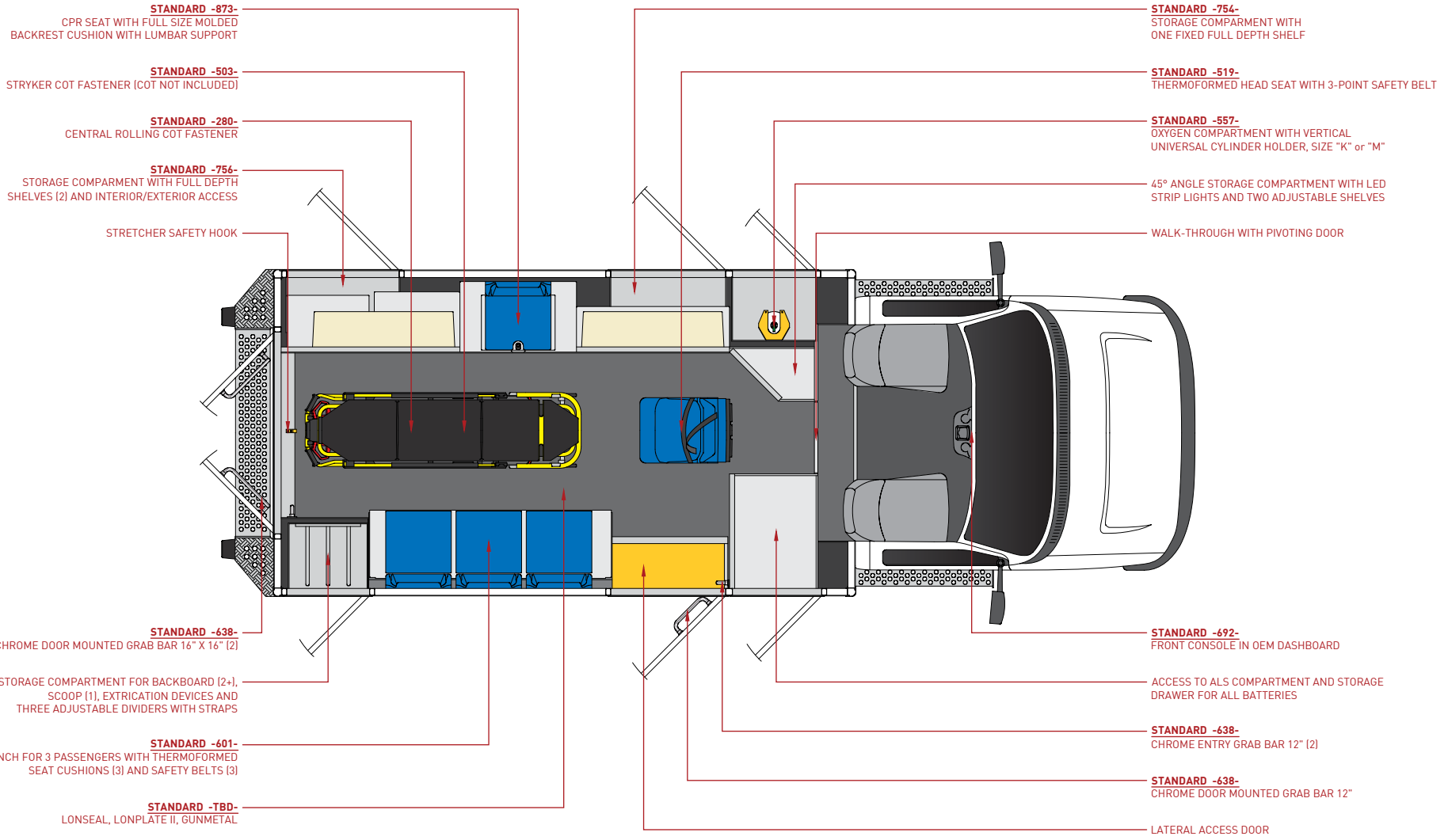

DIMENSIONAL DATA FOR INFORMATION ONLY. DRAWINGS MAY SHOW SOME OPTIONS.

 <p>DEMERS AMBULANCES www.demers-ambulances.com</p>	DESCRIPTION : TYPE III --- FLOOR VIEW - STANDARD			DRAWING NO.	
	CONTRACT	CHASSIS	MODEL	DESIGNER :	
	MX170E	CHEVROLET	G4500	BENOIT LANDRY	
	2014	SCALE	PAGE	SALES :	REV.: 0
	1 : 45	28 / 37	DEALER :		MODULE NO. B800618

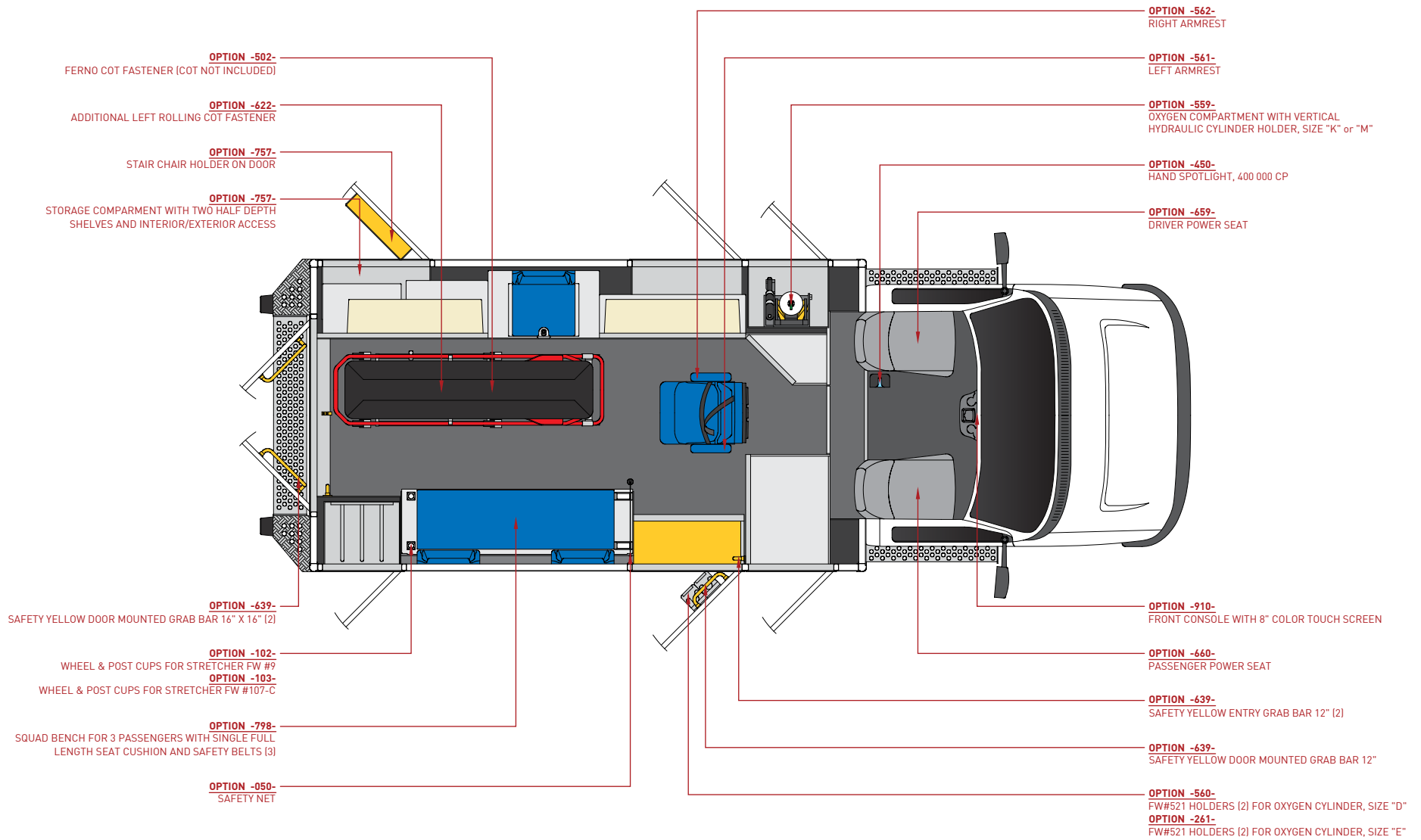

DIMENSIONAL DATA FOR INFORMATION ONLY. DRAWINGS MAY SHOW SOME OPTIONS.

 <p>DEMERS AMBULANCES www.demers-ambulances.com</p>	DESCRIPTION : TYPE III --- FLOOR VIEW - OPTION #1			DRAWING NO.		
	CONTRACT	MX170E	CHASSIS	MODEL	DESIGNER :	31GM-G4500XX-C4-0337
		2014	CHEVROLET	G4500	BENOIT LANDRY	
		SCALE	PAGE	SALES :	REV.: 0	DATE: 2014-01-21
	1 : 45	29 / 37	DEALER :	MODULE NO. B800618		

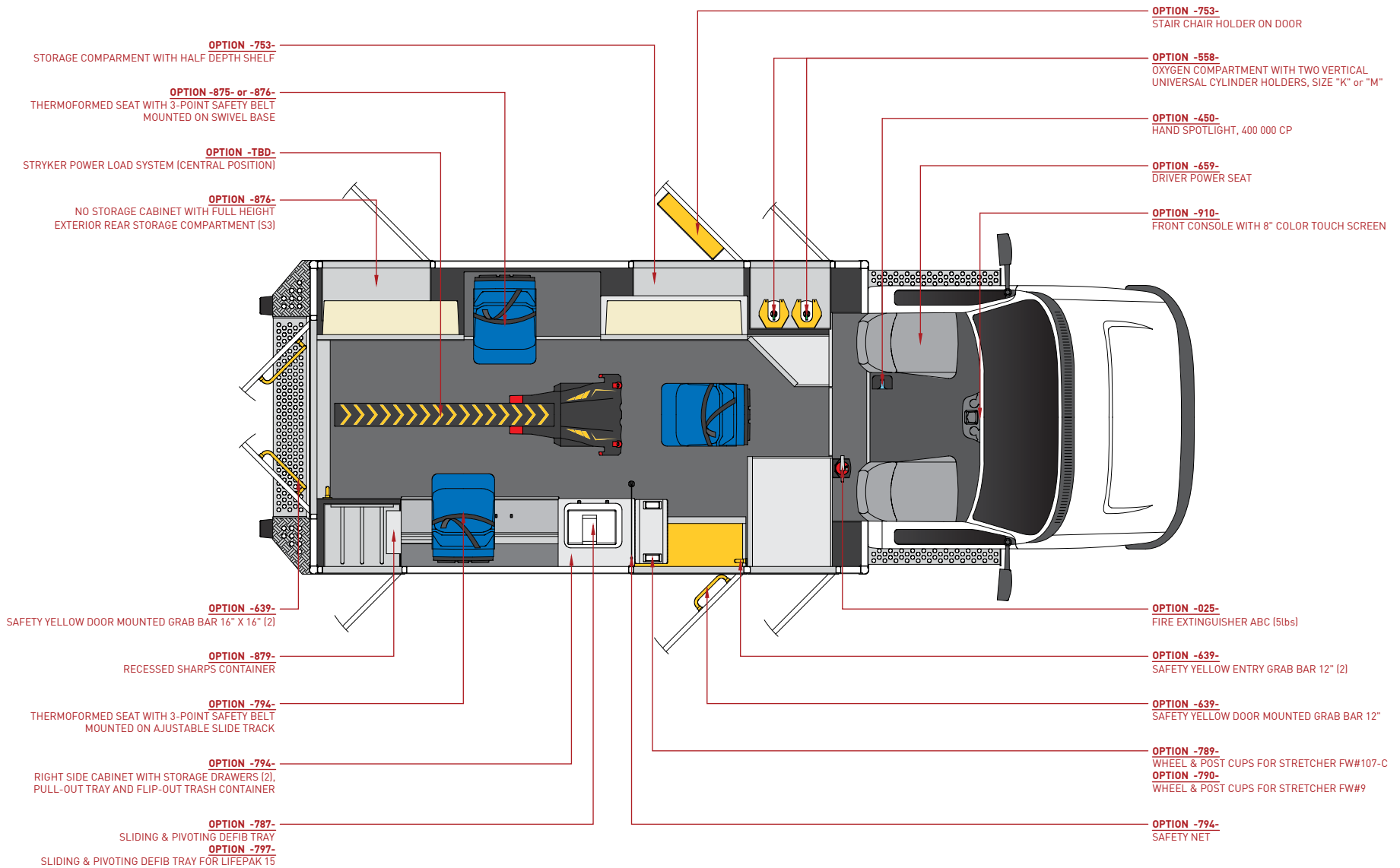

DIMENSIONAL DATA FOR INFORMATION ONLY. DRAWINGS MAY SHOW SOME OPTIONS.

 <p>DEMERS AMBULANCES www.demers-ambulances.com</p>	DESCRIPTION : TYPE III --- FLOOR VIEW - OPTION #2			DRAWING NO.	
	CONTRACT	CHASSIS	MODEL	DESIGNER :	
		CHEVROLET	G4500	BENOIT LANDRY	
	MX170E	SCALE	PAGE	SALES :	REV.: 0
2014		1 : 45	DEMERS AMBULANCES		
			DEALER :	MODULE NO. B800618	

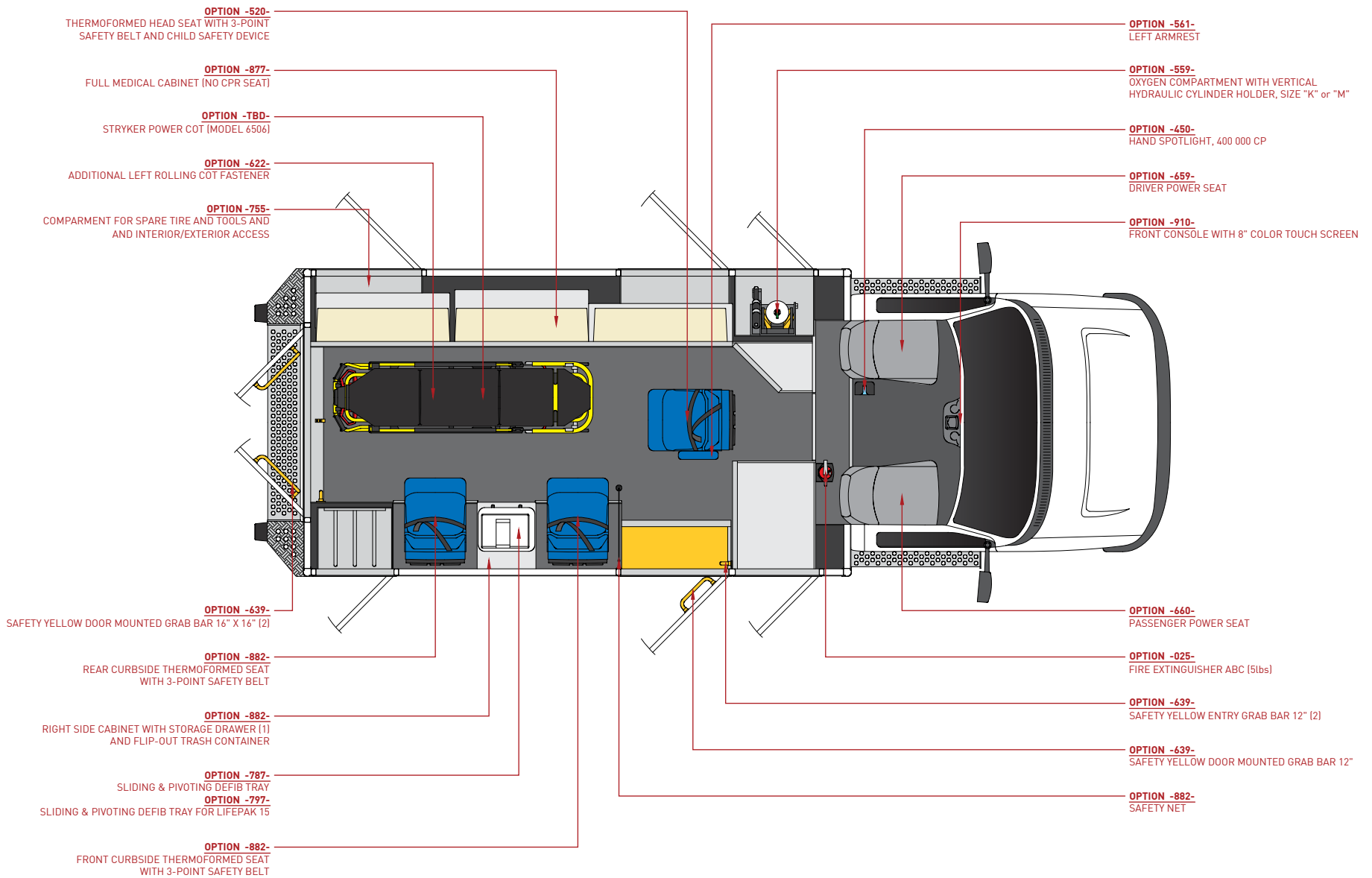

DIMENSIONAL DATA FOR INFORMATION ONLY. DRAWINGS MAY SHOW SOME OPTIONS.

 <p>DEMERS AMBULANCES www.demers-ambulances.com</p>	DESCRIPTION : TYPE III --- FLOOR VIEW - OPTION #3			DRAWING NO.	
	CONTRACT	CHASSIS	MODEL	DESIGNER :	
	MX170E	CHEVROLET	G4500	BENOIT LANDRY	
	2014	SCALE	PAGE	SALES :	REV.: 0
	1 : 45	31 / 37	DEALER :		MODULE NO. B800618

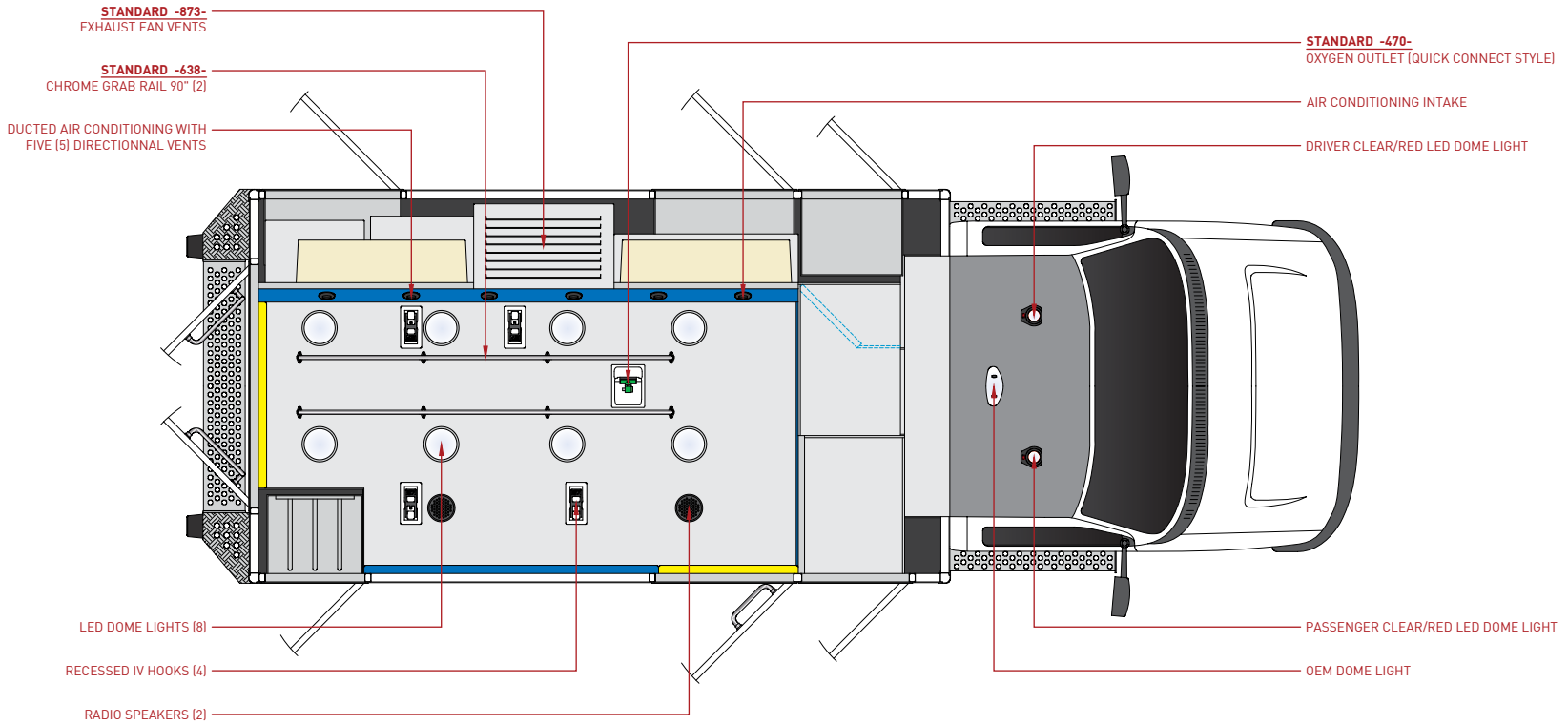

DIMENSIONAL DATA FOR INFORMATION ONLY. DRAWINGS MAY SHOW SOME OPTIONS.

 <p>DEMERS AMBULANCES www.demers-ambulances.com</p>	DESCRIPTION : TYPE III --- CEILING VIEW - STANDARD			DRAWING NO.	
	CONTRACT	CHASSIS	MODEL	DESIGNER :	
		CHEVROLET	G4500	BENOIT LANDRY	
	MX170E	SCALE	PAGE	SALES :	
2014		1 : 45	DEMERS AMBULANCES		
			DEALER :	REV.: 0	DATE: 2014-01-21
				MODULE NO. B800618	

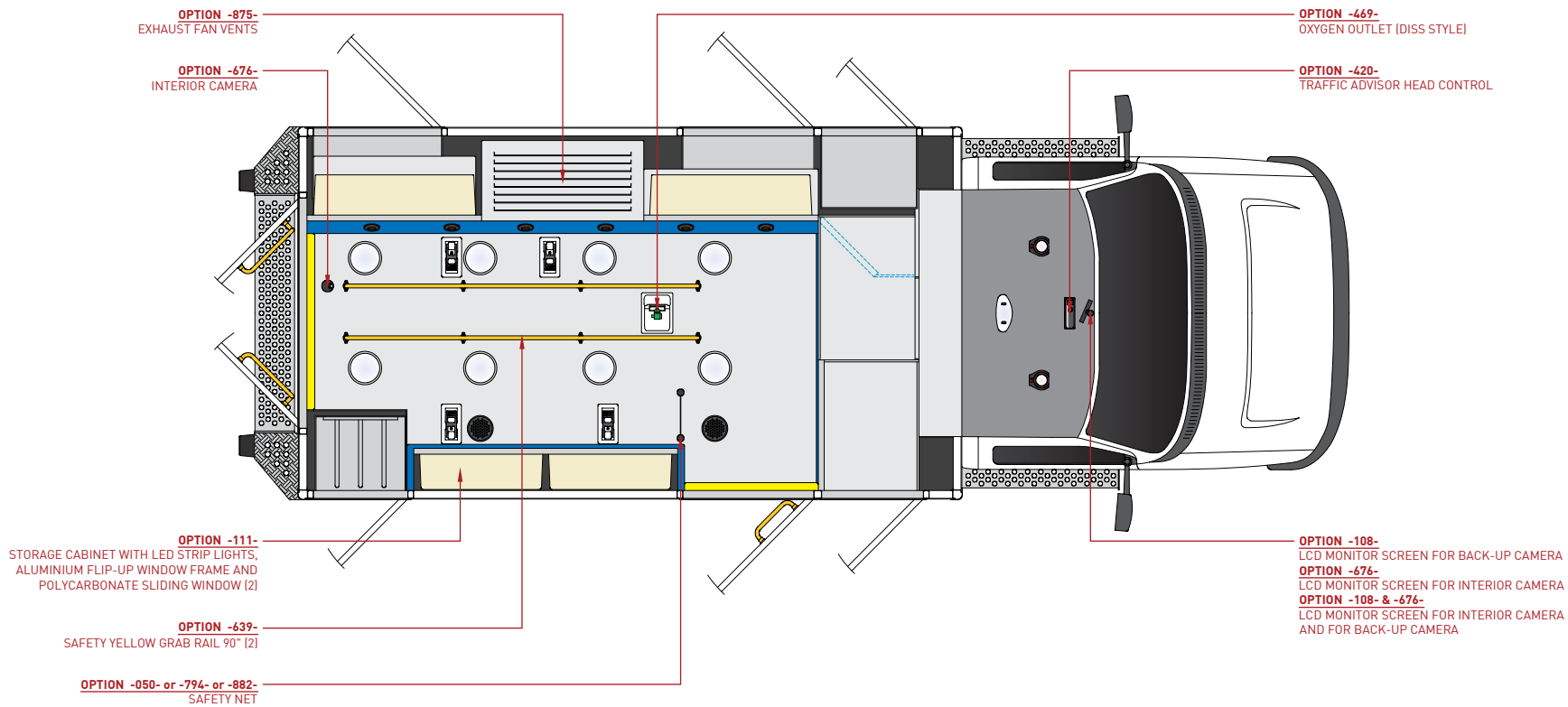

DIMENSIONAL DATA FOR INFORMATION ONLY. DRAWINGS MAY SHOW SOME OPTIONS.

 <p>DEMERS AMBULANCES www.demers-ambulances.com</p>	DESCRIPTION : TYPE III --- CEILING VIEW - OPTION			DRAWING NO.	
	CONTRACT	CHEVROLET	MODEL	DESIGNER :	
			G4500	BENOIT LANDRY	
	MX170E	SCALE	PAGE	SALES :	REV.: 0
2014			1 : 45	33 / 37	DEALER :
			MODULE NO.		B800618

FRONT CONSOLE
STANDARD : 692

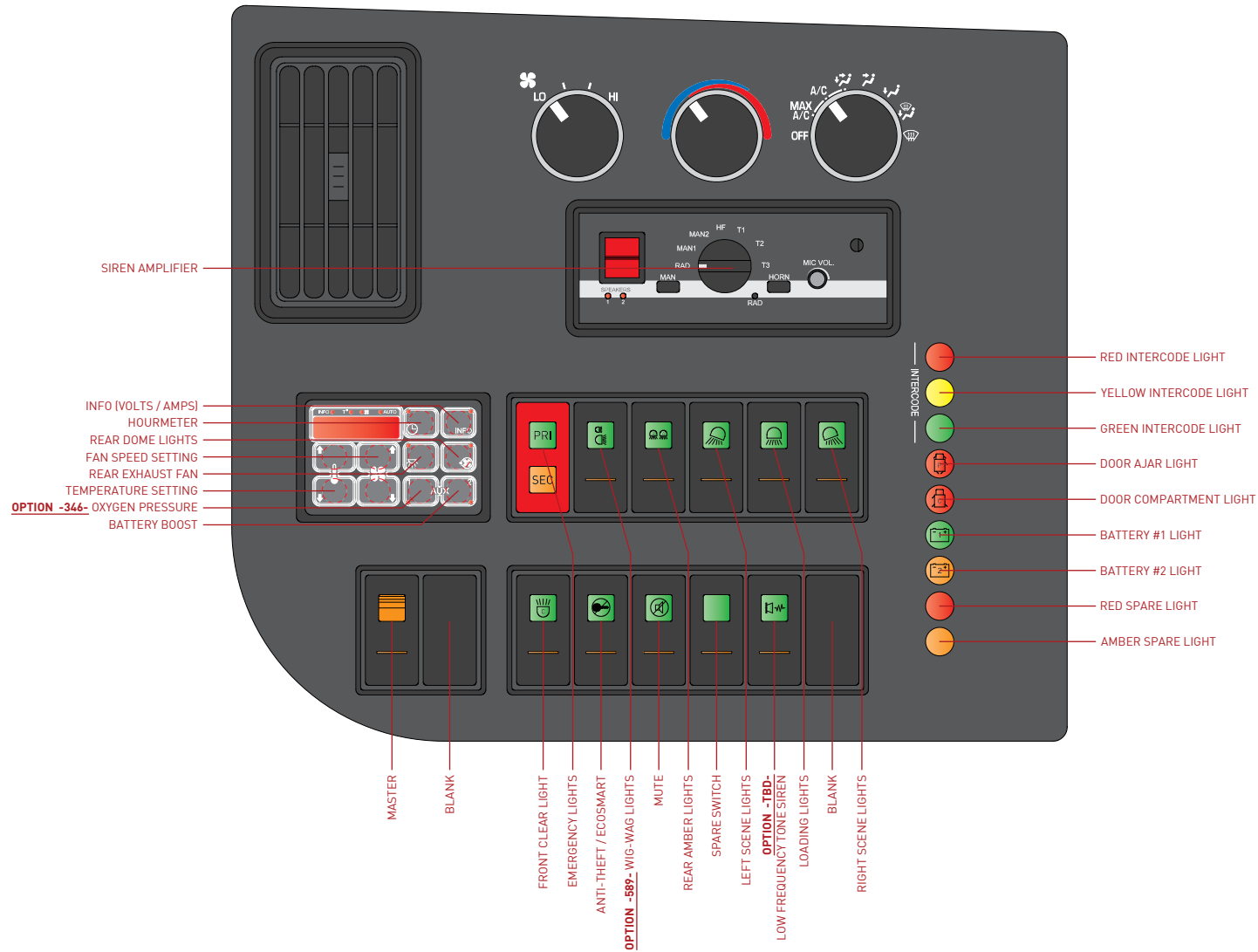

DIMENSIONAL DATA FOR INFORMATION ONLY. DRAWINGS MAY SHOW SOME OPTIONS.

 <p>DEMERS AMBULANCES www.demers-ambulances.com</p>	DESCRIPTION : TYPE III --- FRONT CONSOLE - STANDARD			DRAWING NO.	
	CONTRACT	CHASSIS	MODEL	DESIGNER :	
	MX170E	CHEVROLET	G4500	BENOIT LANDRY	
	2014	SCALE	PAGE	SALES :	REV.: 0
	1 : 3	34 / 37	DEALER :		MODULE NO. B800618

FRONT CONSOLE

OPTION -910-

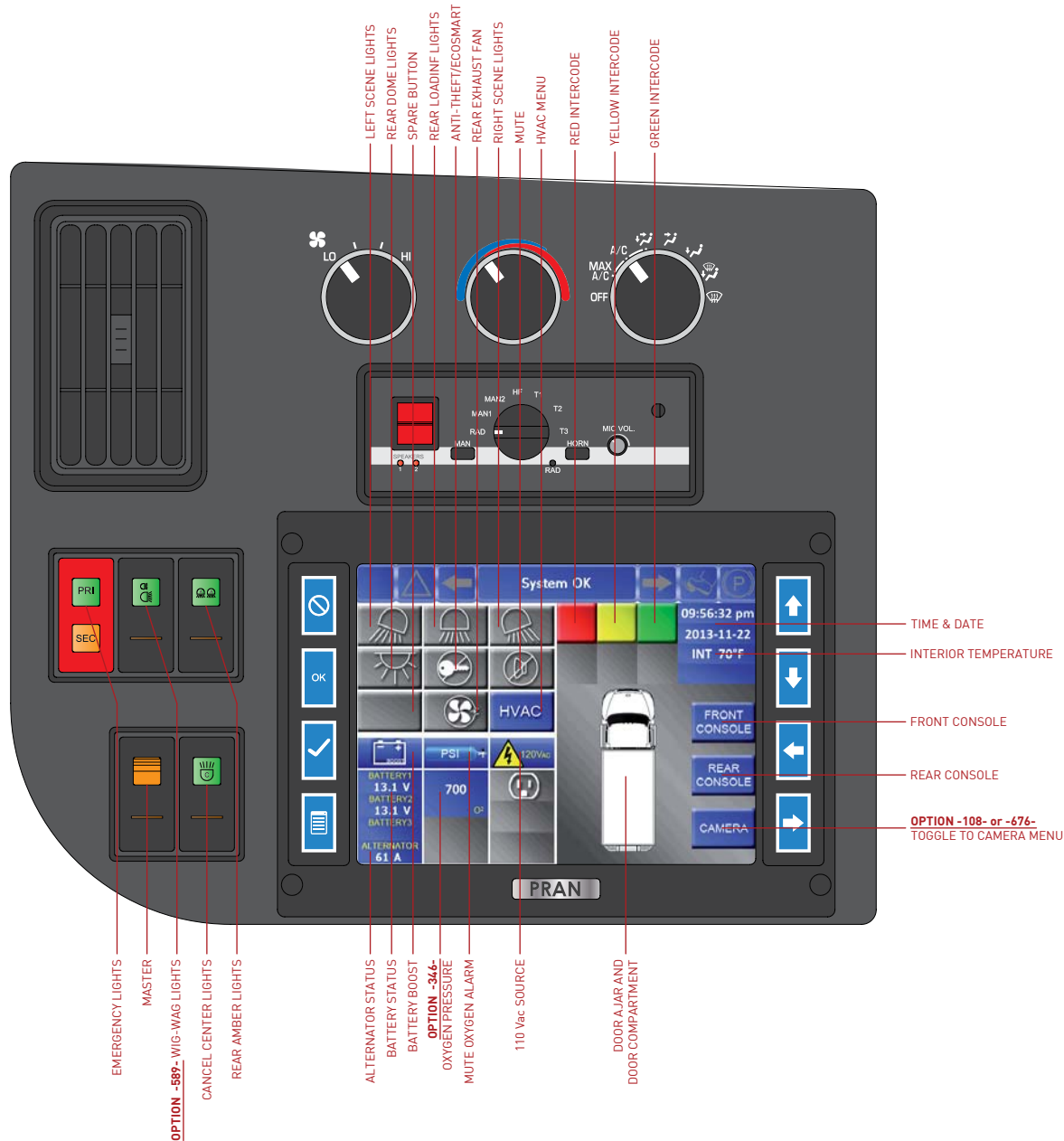

DIMENSIONAL DATA FOR INFORMATION ONLY. DRAWINGS MAY SHOW SOME OPTIONS.

 <p>DEMERS AMBULANCES www.demers-ambulances.com</p>	DESCRIPTION : TYPE III --- FRONT CONSOLE - OPTION			DRAWING NO.	
	CONTRACT	CHASSIS	MODEL	DESIGNER :	31GM-G4500XX-C4-0343
	MX170E	CHEVROLET	G4500	BENOIT LANDRY	
	2014	SCALE	PAGE	SALES :	REV.: 0 DATE: 2014-01-21
	1 : 3	35 / 37	DEALER :	MODULE NO. B800618	

REAR CONSOLE
STANDARD -899-

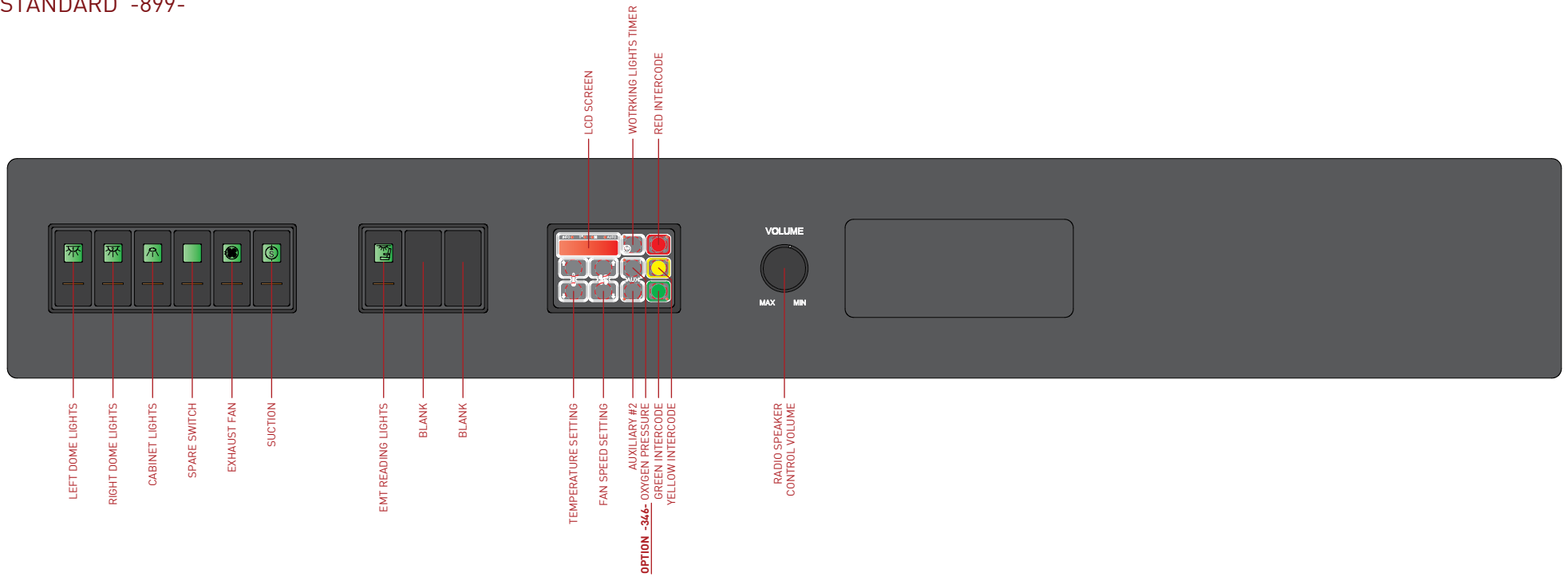

AUXILIARY REAR CONSOLE
OPTION -911-

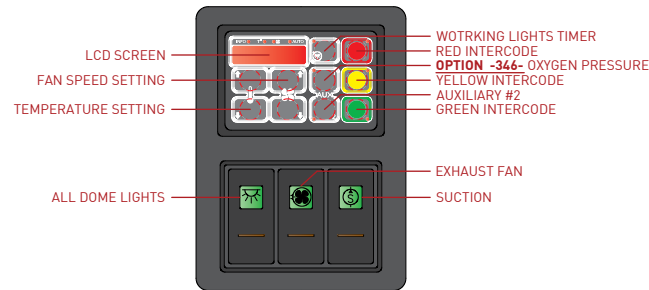

DIMENSIONAL DATA FOR INFORMATION ONLY. DRAWINGS MAY SHOW SOME OPTIONS.

 <p>DEMERS AMBULANCES www.demers-ambulances.com</p>	DESCRIPTION : TYPE III --- REAR CONSOLES - STANDARD			DRAWING NO.	
	CONTRACT	CHASSIS	MODEL	DESIGNER :	
				BENOIT LANDRY	
	MX170E	CHEVROLET	G4500	SALES :	REV.: 0
2014	SCALE	PAGE	DEALER :		MODULE NO. B800618
	1 : 4	36 / 37			

REAR CONSOLE STANDARD -842-

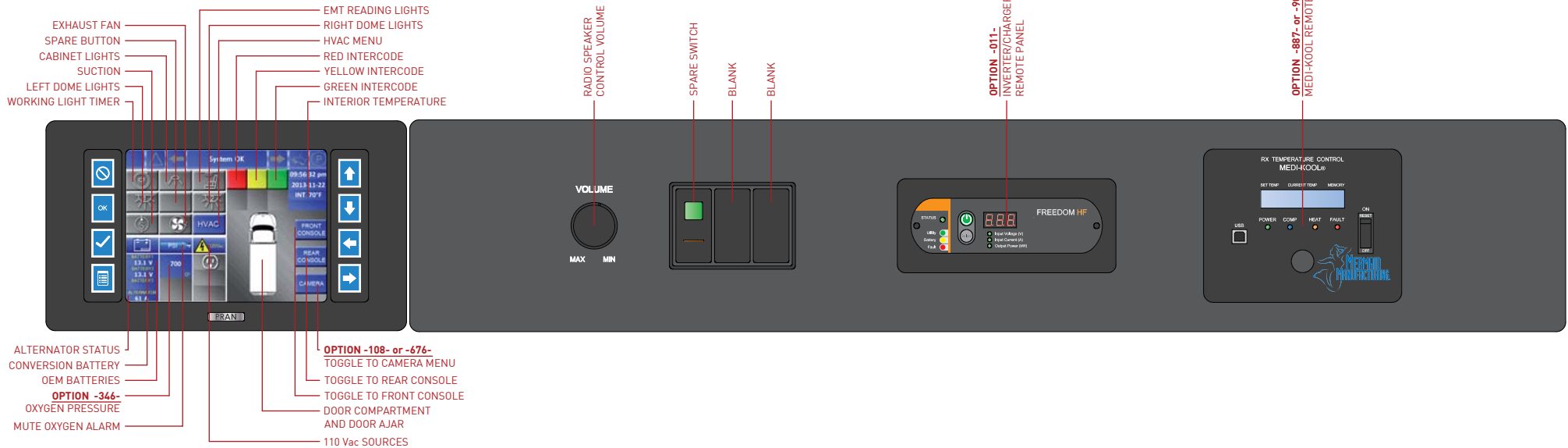

AUXILIARY REAR CONSOLE

OPTION -522- or
OPTION -796-

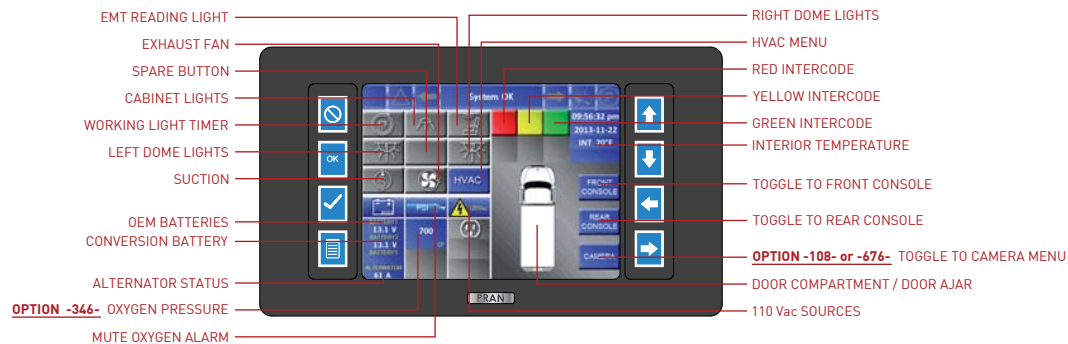

DIMENSIONAL DATA FOR INFORMATION ONLY. DRAWINGS MAY SHOW SOME OPTIONS.

 <p>DEMERS AMBULANCES www.demers-ambulances.com</p>	DESCRIPTION : TYPE III --- REAR CONSOLES - OPTION			DRAWING NO.	
	CONTRACT	CHASSIS	MODEL	DESIGNER :	31GM-G4500XX-C4-0345
	MX170E	CHEVROLET	G4500	BENOIT LANDRY	
	2014	SCALE	PAGE	SALES :	REV.: 0 DATE: 2014-01-21
	1 : 4	37 / 37	DEALER :	MODULE NO. B800618	