

Dealer:

Approved By:

Date:

Customer:

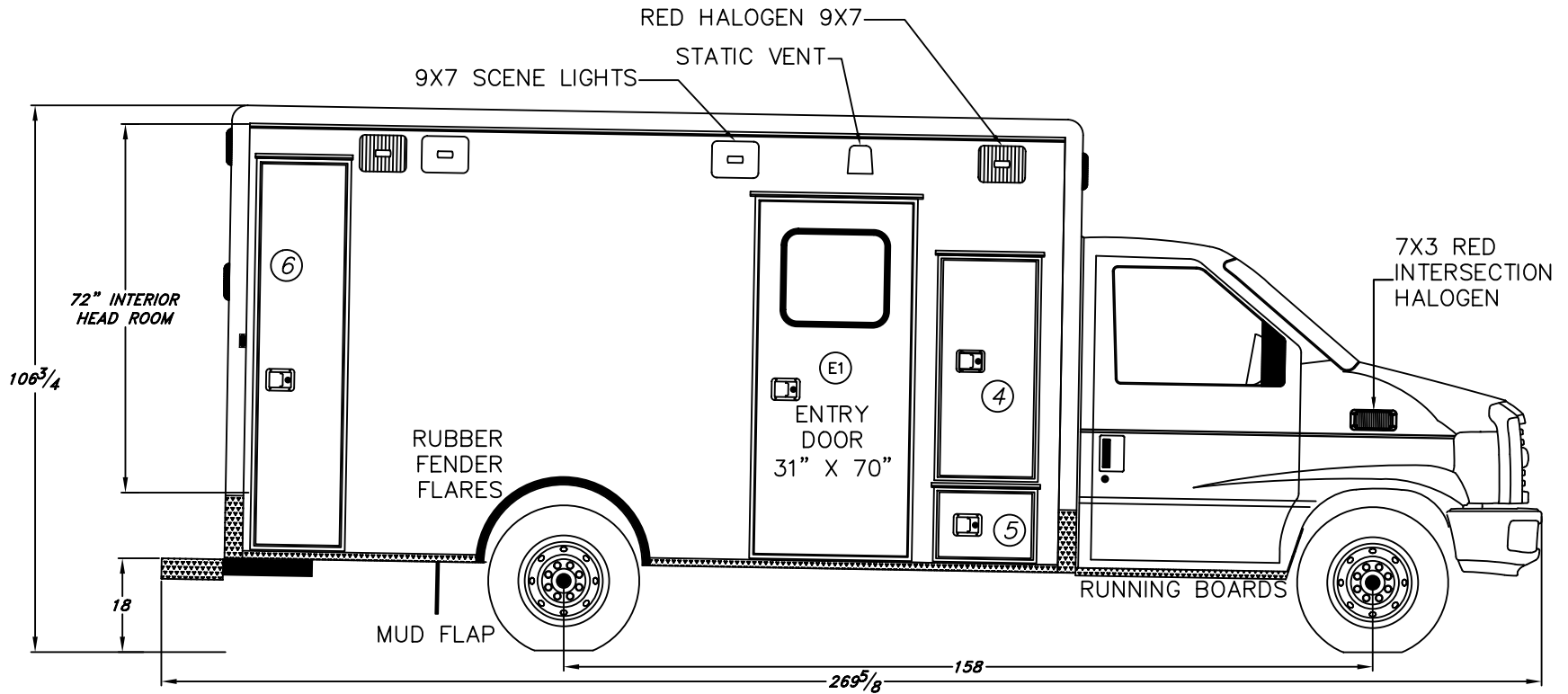

ENTRY & COMPARTMENT DOORS					* COMP/ENTRY DOOR SIZES			PLEASE NOTE: THE DIMENSIONS BELOW ARE ROUGH OPENINGS YOU MUST SUBTRACT 1/4" FOR TUB SIZE			DOOR SIZES	
					NO.	COMPARTMENT TYPE	WIDTH	HEIGHT	DEPTH	WIDTH	HEIGHT	
E1	02-7508				4	ALS COMPARTMENT	19 1/2"	43 5/16"	31"	18 1/8"	42 1/8"	
4	02-7509				5	BATTERY STORAGE	19 1/2"	14"	20 1/4"	18 1/8"	12 5/8"	
5	02-7500				6	BACKBOARD STORAGE	18"	76"	23"	16 3/8"	74 3/8"	
6	02-7503											
COMPARTMENT TUBS					FORD E-450 158" W.B.							
5	02-1164				166 TYPE III AMBULANCE							
6	02-1165				CURB SIDE EXTERIOR							
					DESCRIPTION:							
					DRAWN BY:	Kurt E	DATE CREATED:	2-24-09	DRAWING NUMBER:	A		

MEDIX 3008 MOBILE DRIVE
 ELKHART, IN 46514
 PH: 574-266-0911
 SPECIALTY VEHICLES, INC. FAX: 574-266-6669
 "LET US SHOW YOU THE MEDIX DIFFERENCE"
 WWW.MEDIXAMBULANCE.COM

Dealer:

Approved By:

Date:

Customer:

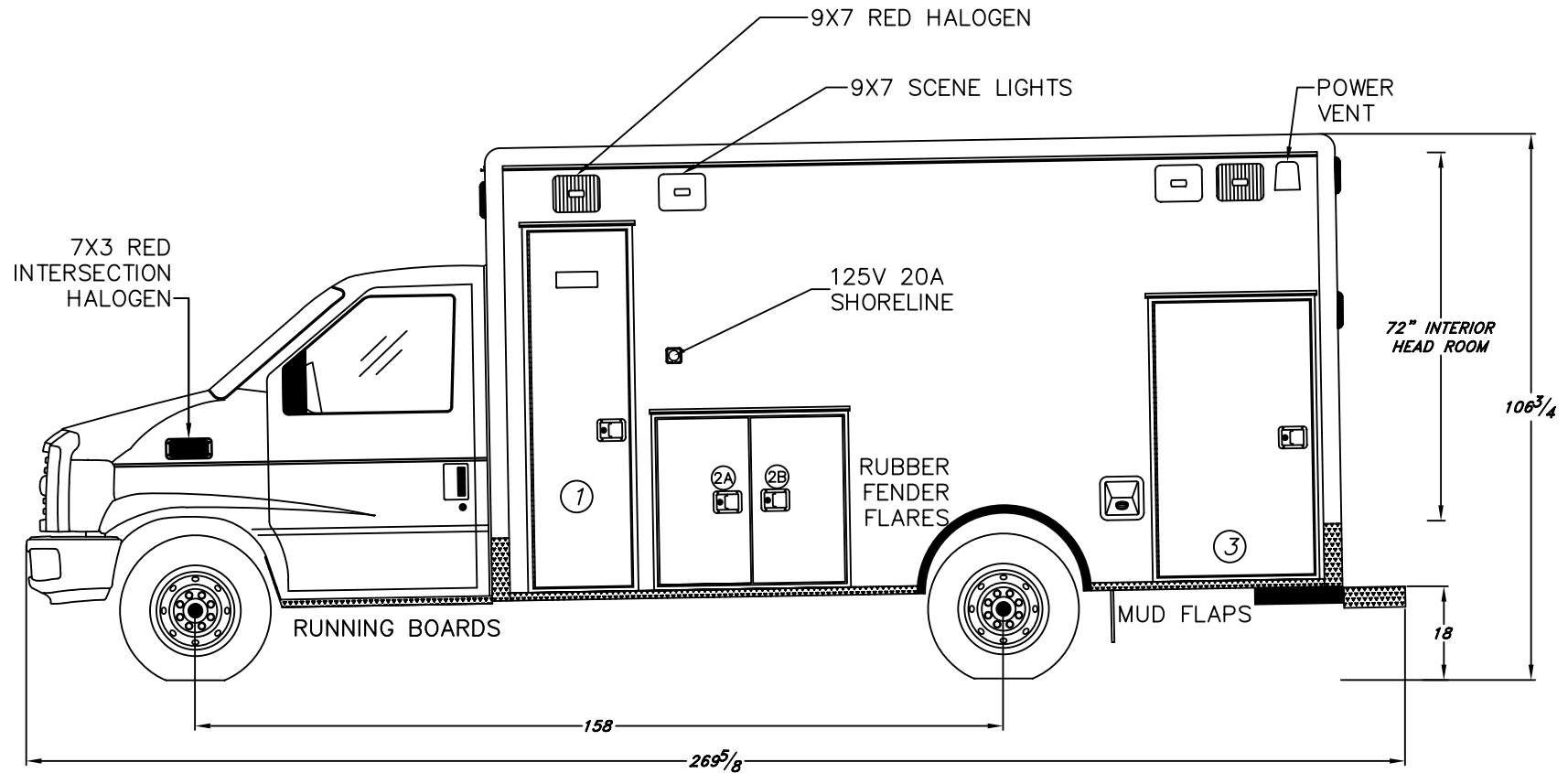

ENTRY & COMPARTMENT DOORS					* COMP/ENTRY DOOR SIZES	PLEASE NOTE: THE DIMENSIONS BELOW ARE ROUGH OPENINGS YOU MUST SUBTRACT 1/4" FOR TUB SIZE			DOOR SIZES		
NO.	PART NO.				NO.	COMPARTMENT TYPE	WIDTH	HEIGHT	DEPTH	WIDTH	HEIGHT
1	02-7505				1	OXYGEN COMPARTMENT	19 1/2"	70"	18 3/4"	17 7/8"	68 3/8"
2A	02-7512				2	DUAL DOOR STORAGE COMP	38"	34"	21 1/4"	NA	NA
2B	02-7511				3	REAR STORAGE COMPARTMENT	31"	54"	21 3/4"	29 3/8"	52 3/8"
3	02-7507										
COMPARTMENT TUBS					FORD E-450 158" W.B. 166 TYPE III AMBULANCE DESCRIPTION: STREET SIDE EXTERIOR DRAWN BY: Kurt E DATE CREATED: DRAWING NUMBER: B						
1	02-7013				 3008 MOBILE DRIVE ELKHART, IN 46514 PH: 574-266-0911 SPECIALTY VEHICLES, INC. FAX: 574-266-6669 "LET US SHOW YOU THE MEDIX DIFFERENCE" WWW.MEDIXAMBULANCE.COM						
2	02-7014										
3	02-7016										

Dealer:

Approved By:

Date:

Customer:

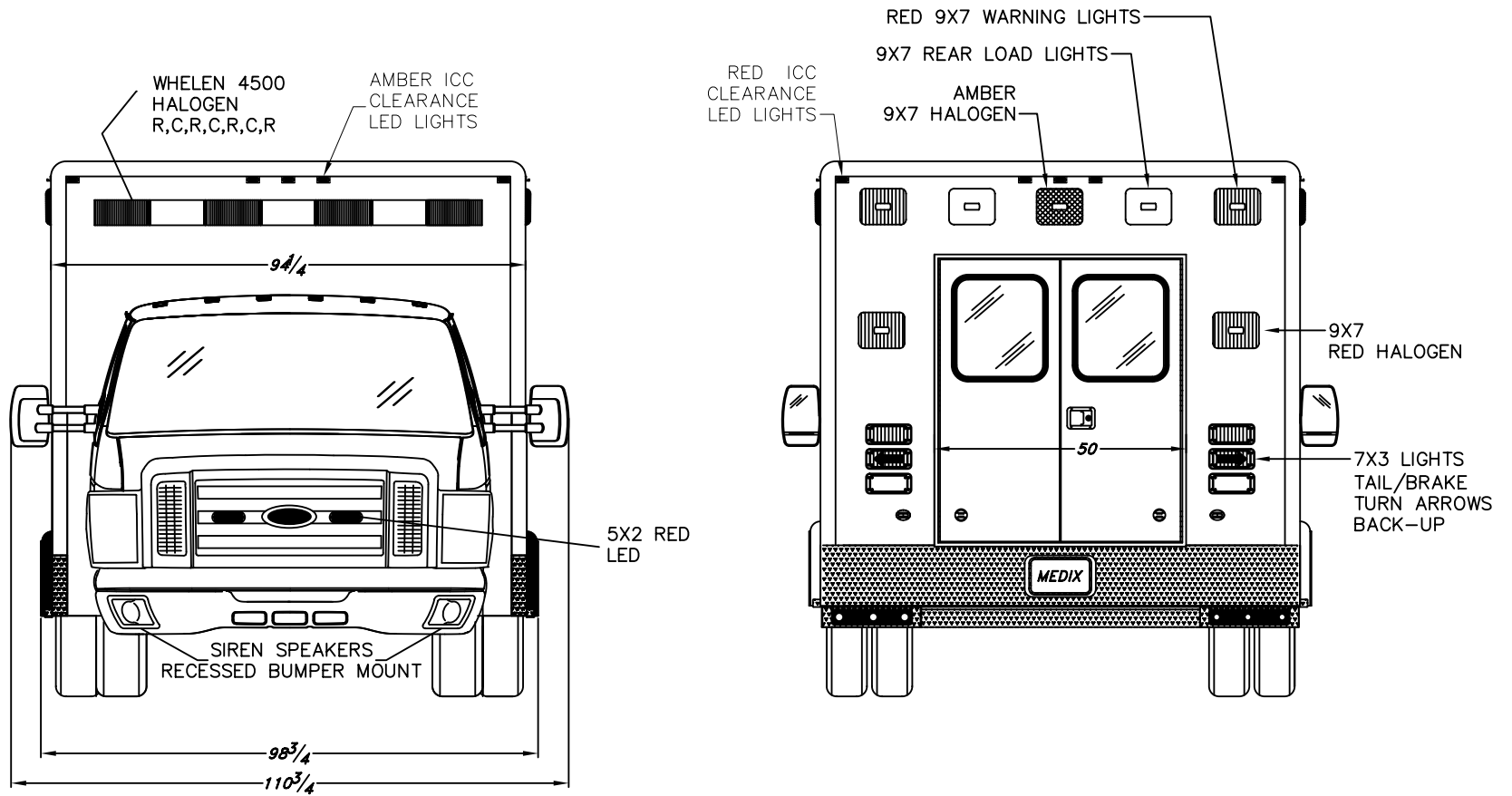

FORD E-450 158" W.B.		
166 TYPE III AMBULANCE		
DESCRIPTION: FRONT & REAR EXTERIOR		
DRAWN BY: Kurt E	DATE CREATED: 2-24-09	DRAWING NUMBER: C

MEDIX
 SPECIALTY VEHICLES, INC.

3008 MOBILE DRIVE
 ELKHART, IN 46514
 PH: 574-266-0911
 FAX: 574-266-6669

"LET US SHOW YOU THE MEDIX DIFFERENCE"
WWW.MEDIXAMBULANCE.COM

Dealer:

Approved By:

Date:

Customer:

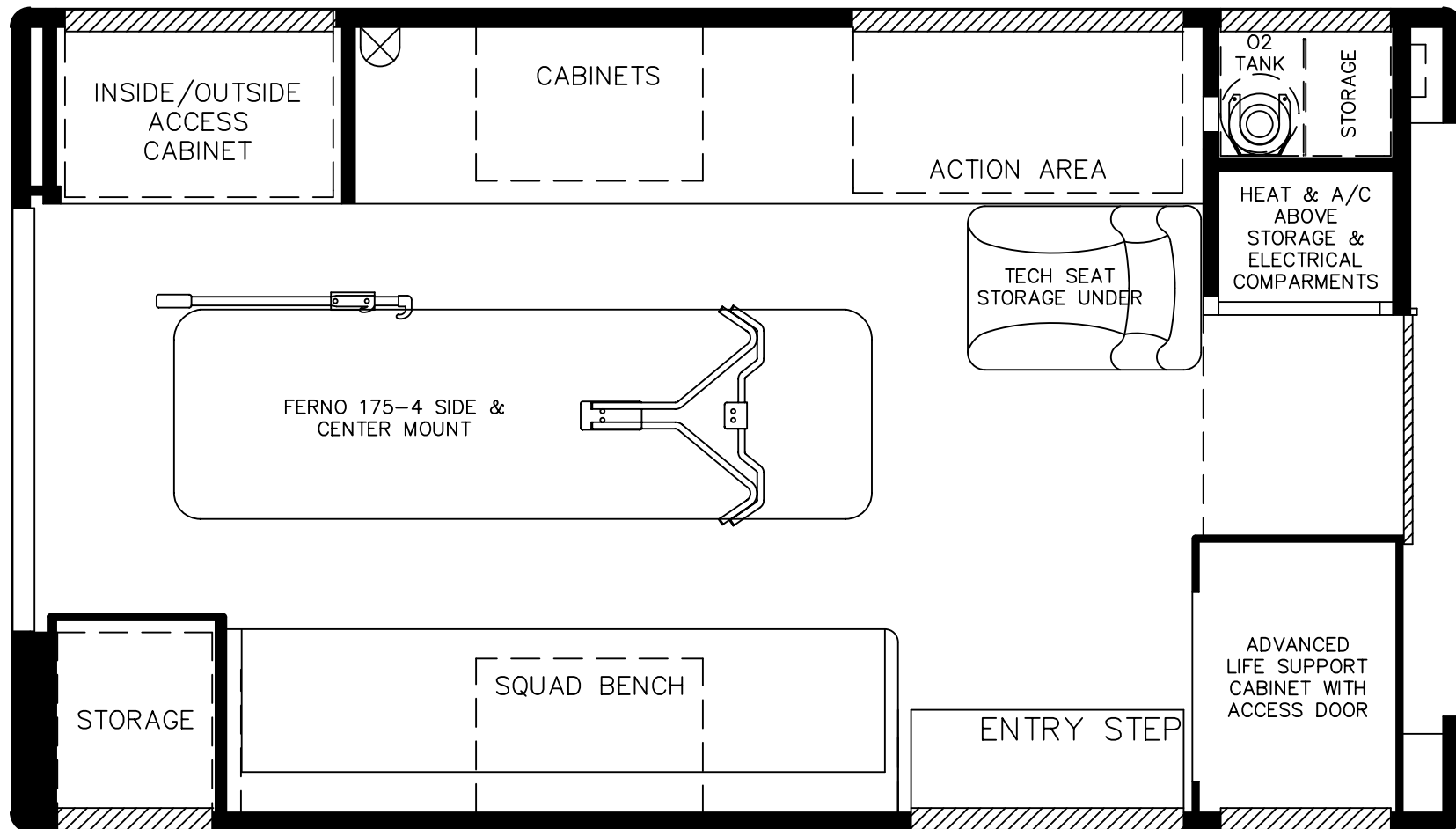

FORD E-450 158" W.B. 166 TYPE III AMBULANCE		
DESCRIPTION: PATIENT PLAN AREA		
DRAWN BY: Kurt E	DATE CREATED: 2-24-09	DRAWING NUMBER: D

3008 MOBILE DRIVE
 ELKHART, IN 46514
 PH: 574-266-0911
 FAX: 574-266-6669

MEDIX
 SPECIALTY VEHICLES, INC.

"LET US SHOW YOU THE MEDIX DIFFERENCE"
 WWW.MEDIXAMBULANCE.COM

Dealer:

Approved By:

Date:

Customer:

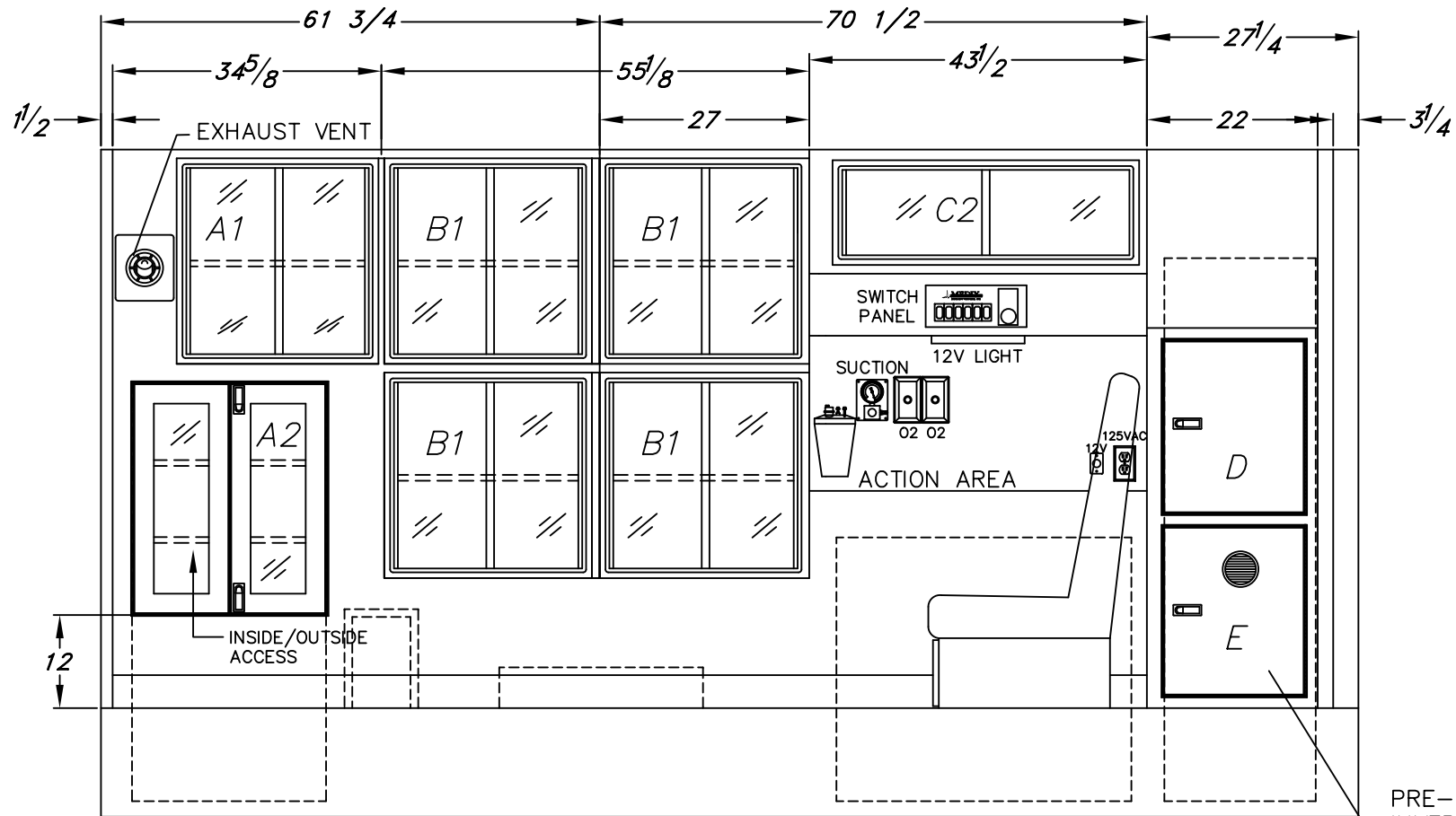

INTERIOR CABINET

ITEM	HEIGHT	WIDTH	DEPTH
A1	24 1/2"	26"	21"
A2	30"	20"	20 1/2"
B1	25 1/4"	27"	21"
C2	12"	38"	9 1/2"
D	22"	19"	18 1/4"
E	22"	19"	18 1/4"

FORD E-450 158" W.B.
166 TYPE III AMBULANCE

DESCRIPTION:

STREET SIDE INTERIOR

DRAWN BY:

Kurt E

DATE CREATED:

DRAWING NUMBER

E-No CPR



3008 MOBILE DRIVE
ELKHART, IN 46514
PH: 574-266-0911
FAX: 574-266-6669

"LET US SHOW YOU THE MEDIX DIFFERENCE"
WWW.MEDIXAMBULANCE.COM

Dealer:

Approved By:

Date:

Customer:

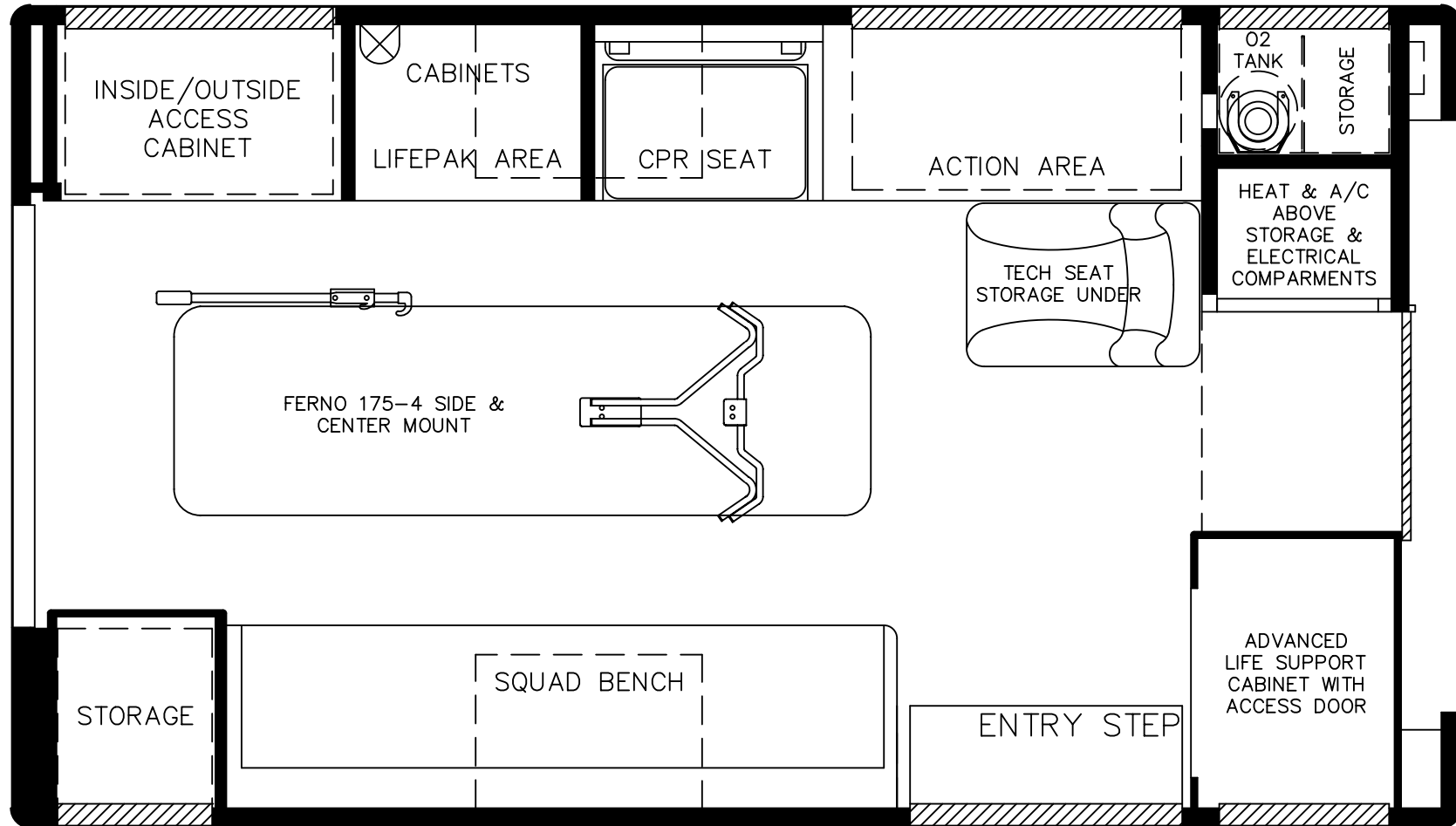

FORD E-450 158" W.B. 166 TYPE III AMBULANCE		
DESCRIPTION: PATIENT PLAN AREA		
DRAWN BY: Kurt E	DATE CREATED: 2-24-09	DRAWING NUMBER: D-CPR

3008 MOBILE DRIVE
 ELKHART, IN 46514
 PH: 574-266-0911
 SPECIALTY VEHICLES, INC. FAX: 574-266-6669

MEDIX
 "LET US SHOW YOU THE MEDIX DIFFERENCE"
 WWW.MEDIXAMBULANCE.COM

Dealer:

Approved By:

Date:

Customer:

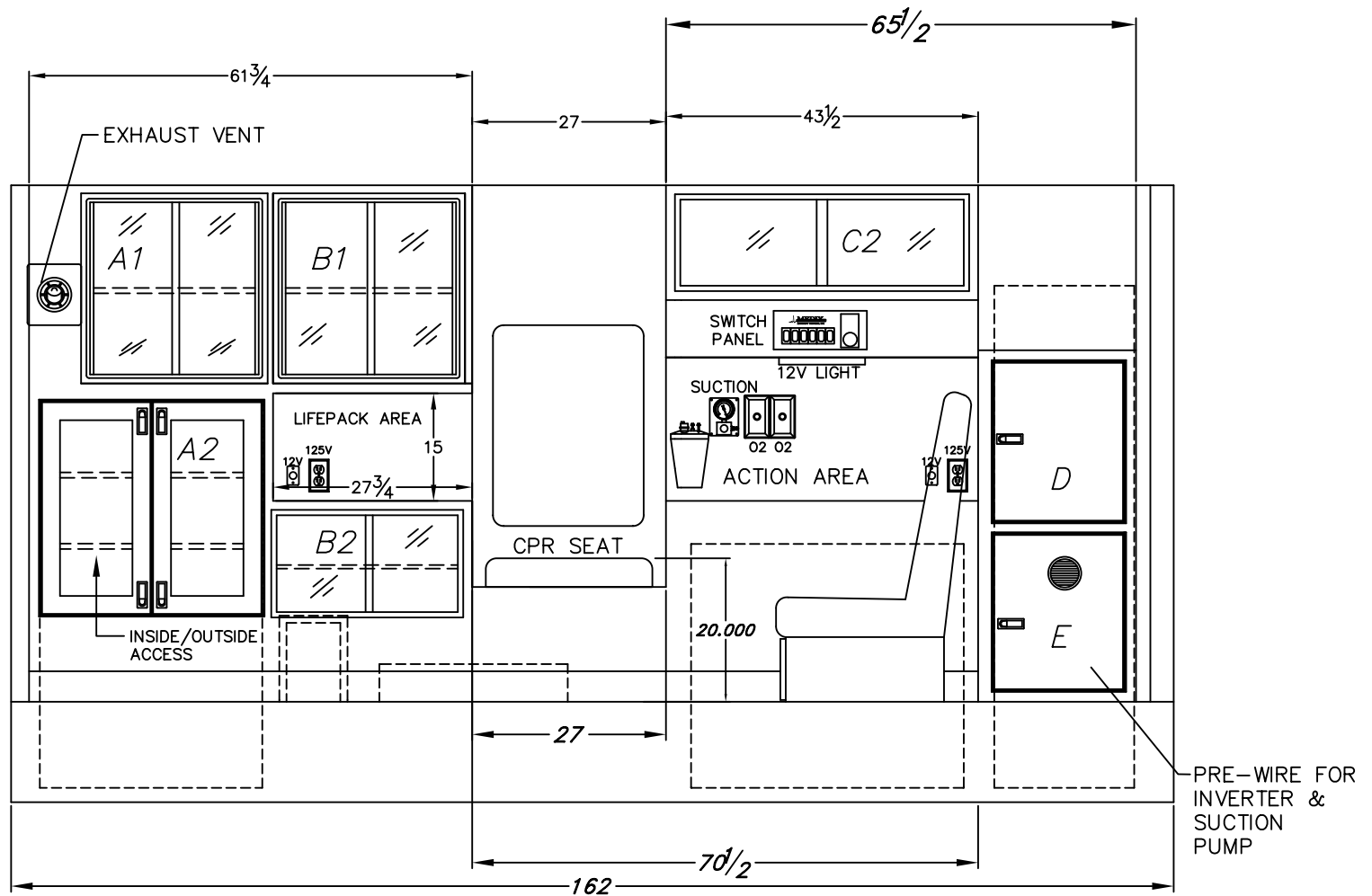

INTERIOR CABINET

ITEM	HEIGHT	WIDTH	DEPTH
A1	24 1/2"	23"	21"
A2	28"	28"	20 1/2"
B1	24 1/2"	24 1/2"	21"
B2	13"	25"	21"
C1	5"	24"	11"
C2	12"	38"	12"
D	22"	19"	18 1/4"
E	22"	19"	18 1/4"

FORD E-450 158" W.B.
166 TYPE III AMBULANCE

DESCRIPTION:

STREET SIDE INTERIOR

DRAWN BY:

Kurt E

DATE CREATED:

DRAWING NUMBER

E-CPR



3008 MOBILE DRIVE
ELKHART, IN 46514
PH: 574-266-0911
FAX: 574-266-6669

"LET US SHOW YOU THE MEDIX DIFFERENCE"
WWW.MEDIXAMBULANCE.COM

Dealer:

Approved By:

Date:

Customer:

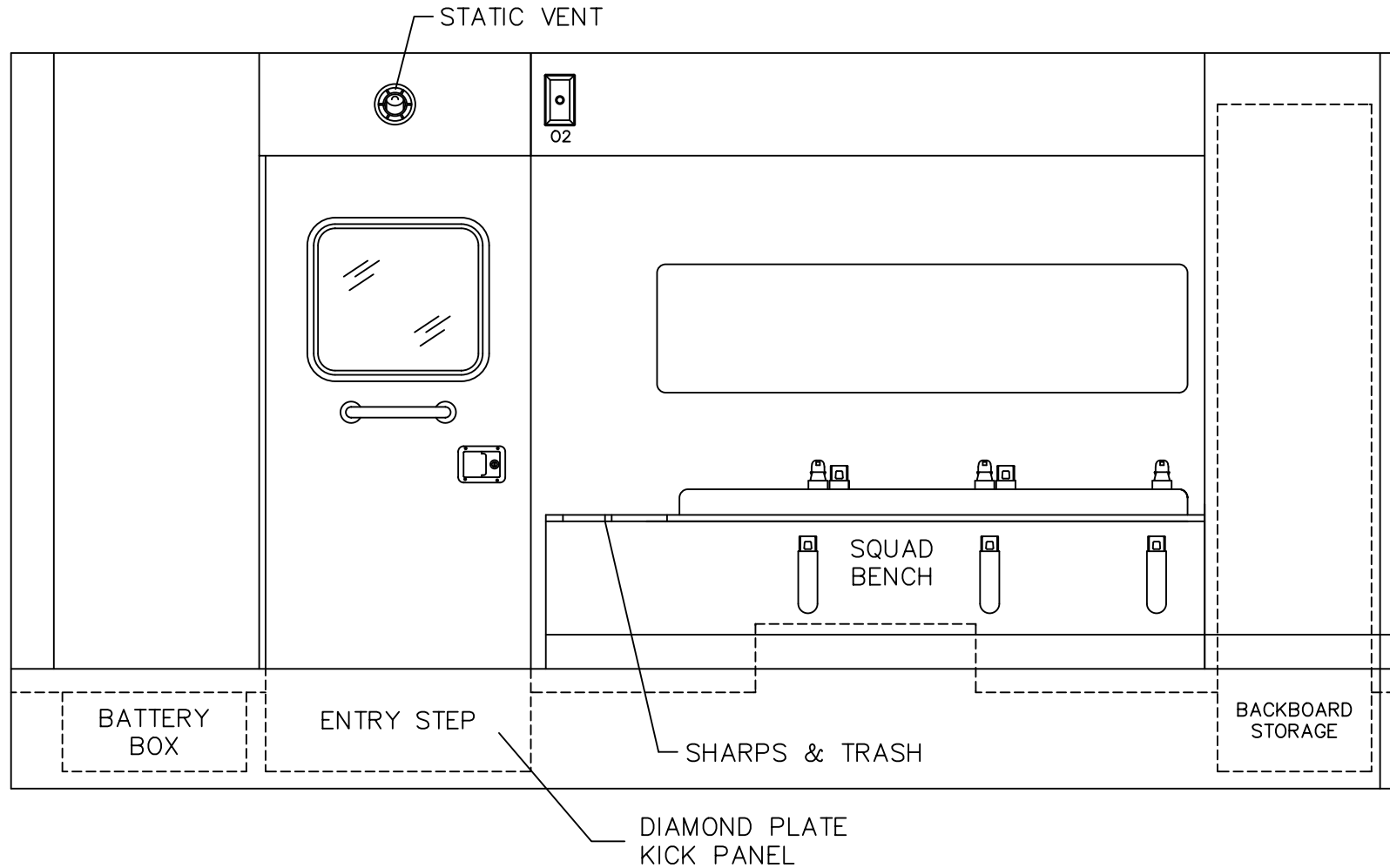

FORD E-450 158" W.B. 166 TYPE III AMBULANCE		
DESCRIPTION: CURB SIDE INTERIOR		
DRAWN BY: Kurt E	DATE CREATED: 2-24-09	DRAWING NUMBER F

3008 MOBILE DRIVE
ELKHART, IN 46514
PH: 574-266-0911
FAX: 574-266-6669

MEDIX
SPECIALTY VEHICLES, INC.

"LET US SHOW YOU THE MEDIX DIFFERENCE"
WWW.MEDIXAMBULANCE.COM

Dealer:

Approved By:

Date:

Customer:

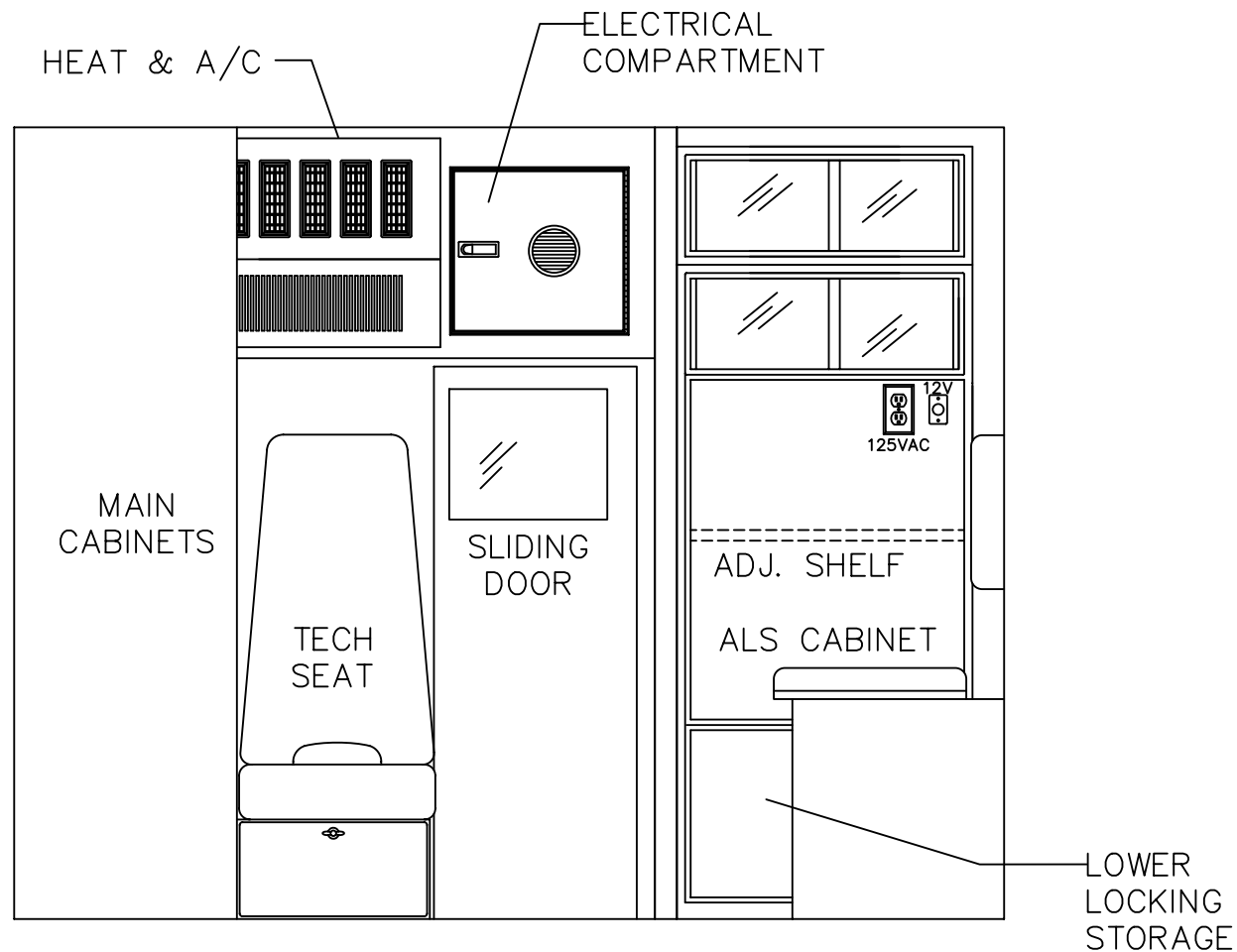

FORD E-450 158" W.B.		
166 TYPE III AMBULANCE		
DESCRIPTION: FRONT BULKHEAD		
DRAWN BY: Kurt E	DATE CREATED:	DRAWING NUMBER G

MEDIX
 SPECIALTY VEHICLES, INC.

3008 MOBILE DRIVE
 ELKHART, IN 46514
 PH: 574-266-0911
 FAX: 574-266-6669

"LET US SHOW YOU THE MEDIX DIFFERENCE"
WWW.MEDIXAMBULANCE.COM

Dealer:

Approved By:

Date:

Customer:

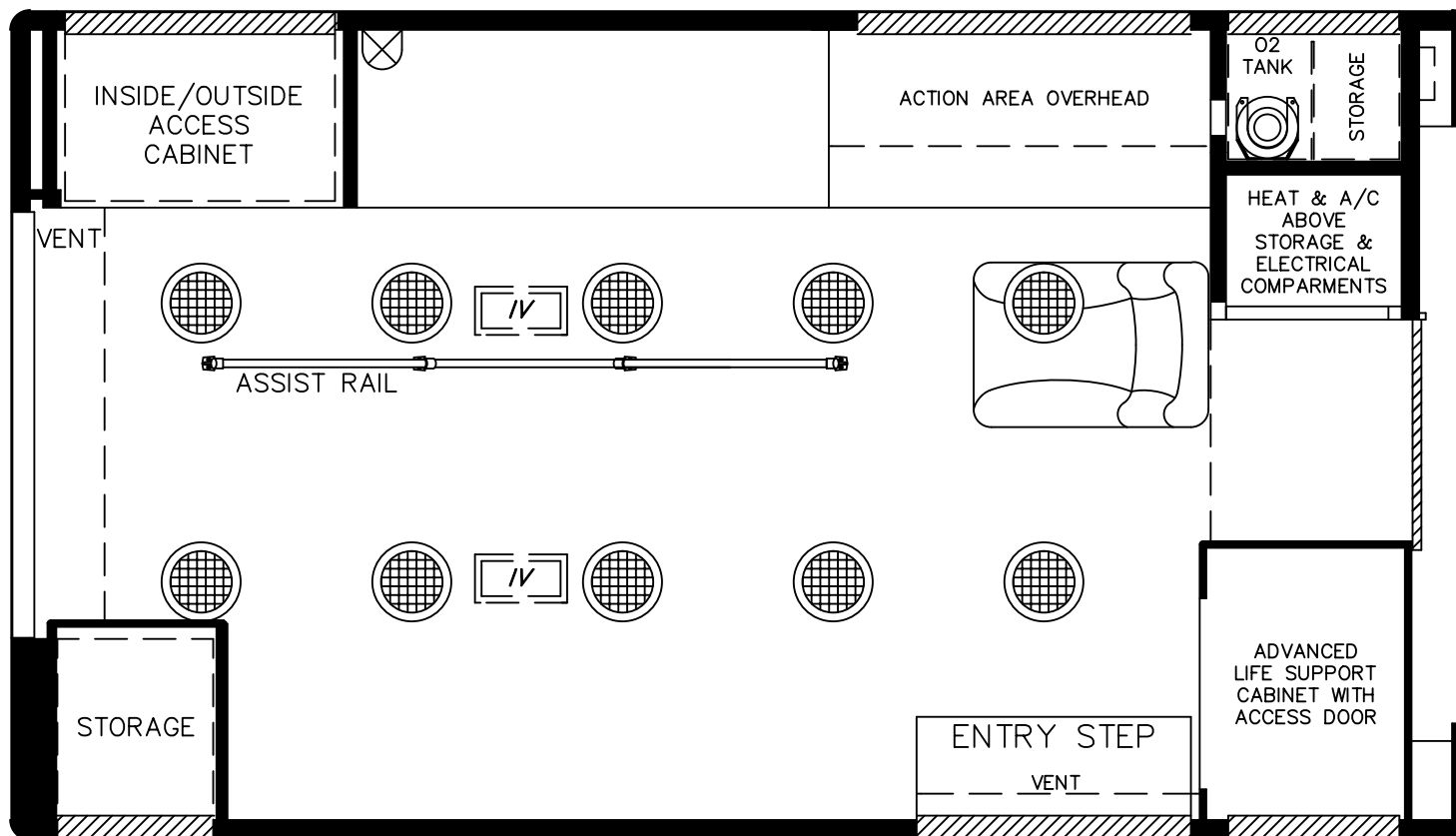

FORD E-450 158" W.B. 166 TYPE III AMBULANCE		
DESCRIPTION:		
PATIENT AREA CEILING		
DRAWN BY:	DATE CREATED:	DRAWING NUMBER
Kurt E		H

MEDIX

3008 MOBILE DRIVE
 ELKHART, IN 46514
 PH: 574-266-0911
 FAX: 574-266-6669

"LET US SHOW YOU THE MEDIX DIFFERENCE"
 WWW.MEDIXAMBULANCE.COM

Dealer:

Approved By:

Date:

Customer:

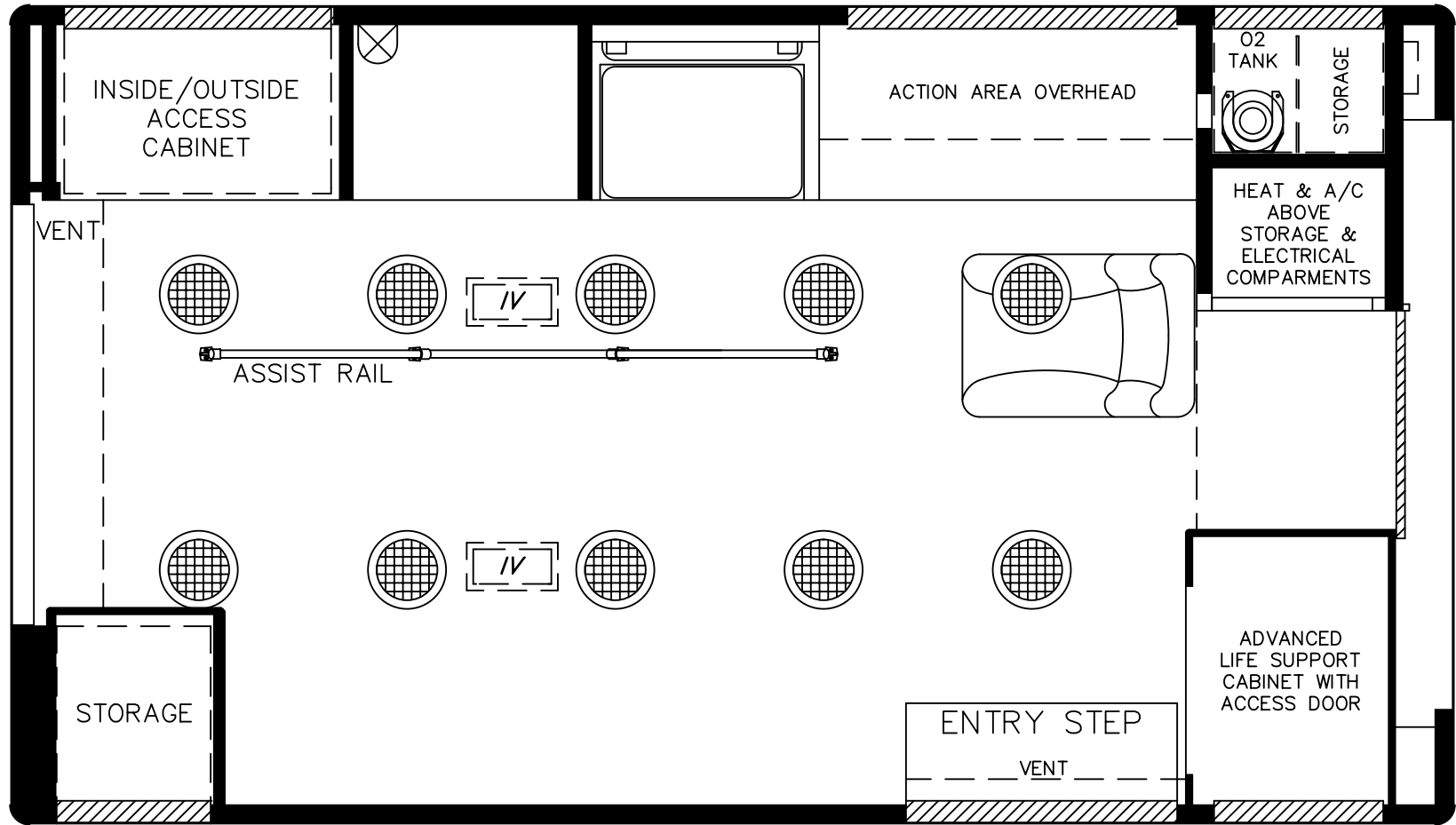

FORD E-450 158" W.B. 166 TYPE III AMBULANCE		
DESCRIPTION:		
PATIENT AREA CEILING		
DRAWN BY:	DATE CREATED:	DRAWING NUMBER
Kurt E		H-CPR

MEDIX

3008 MOBILE DRIVE
 ELKHART, IN 46514
 PH: 574-266-0911
 SPECIALTY VEHICLES, INC. FAX: 574-266-6669

"LET US SHOW YOU THE MEDIX DIFFERENCE"
 WWW.MEDIXAMBULANCE.COM